

UBLights

Lighting & Safety Products



SIGNAL LIGHTS • WORK LIGHTS • WARNING LIGHTS • LIGHT BARS

708.365.8647

ublights.com





UBLights
17311 Martec Int'l Blvd
Country Club Hills, IL 60478

Phone: 708.365.8647 Email: sales@ublights.com
Fax: 708.957.9183 www.ublights.com

All orders of \$300.00 or more ship freight free!

No minimum order.

We reserve the right to correct misprints.

Established in 2007, UBLights is a premier supplier of heavy-duty transportation lighting and safety products. UBLights has spent the past decade improving the lighting options available to our customers, with hands-on approaches at every level of the process.

Our team is involved in the design, testing, and manufacture of our products. We are hands-on at our factories, and work with product design teams to achieve the exacting specs our customers demand. We like to say "Big enough to make it happen, small enough to make it happen fast."

In the process, UBLights has seen extraordinary product growth, and received tremendous brand loyalty. We have worked with some of the major chassis pools to help design specific lights to meet their needs. UBL is the leading brand in the intermodal market today. We have transitioned the majority of our products to LED, which promotes a longer life, uses less energy, and is more durable (no thin filaments) than incandescent alternatives. This focus on LED-forward thinking is key to keeping UBLights at the forefront of transportation lighting technology.

UBLights offers a comprehensive collection of products - trailer and chassis lighting, work light, portable lights, safety lightning options, mirrors, mounting and wiring solutions, and everything your chassis or trailer could need to be in lighting compliance.

Contact us today at info@ublights.com or 708.365.8647 to learn more about how UBLights can meet your customer's lighting and safety needs!



We appreciate your business

Orders of \$300.00 or more ship freight free!

Never a minimum order! Order what you need, when you need it.
All prices are subject to change without notice.

Please visit our web site www.ublights.com for up-to-date new product announcements & specials.

 facebook.com/theublights

 [@ublights_lightingsafety](https://instagram.com/ublights_lightingsafety)



Order Any Time At ublights.com!

We're thrilled to announce the launch of our new eCommerce platform on ublights.com! Starting today, you can shop our complete range of lighting solutions online, all from the comfort of your home, when it's convenient for you!

Our new online store is designed to provide you with a simple shopping experience. Once logged in, you will see your prices and product availability, as well as all your online orders, saved carts, invoices, and more!

What's New?

Explore our extensive catalog of lighting solutions, replacement bulbs, and accessories. Each product comes with specifications and high-quality images to help you make the best choice.

Secure Shopping:
We've implemented the latest security protocols to ensure that your personal information and transactions are protected.

Personal Service: Behind your online order is the UBLights team you have come to know and trust. Reach out as you always have for help or getting answers to your questions.

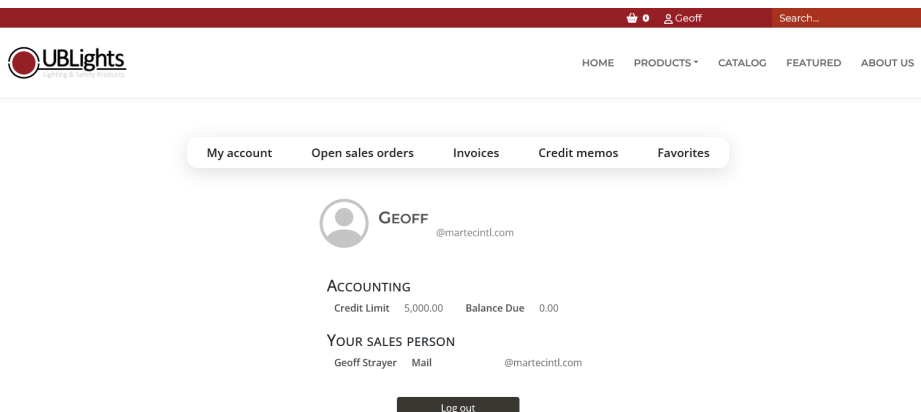
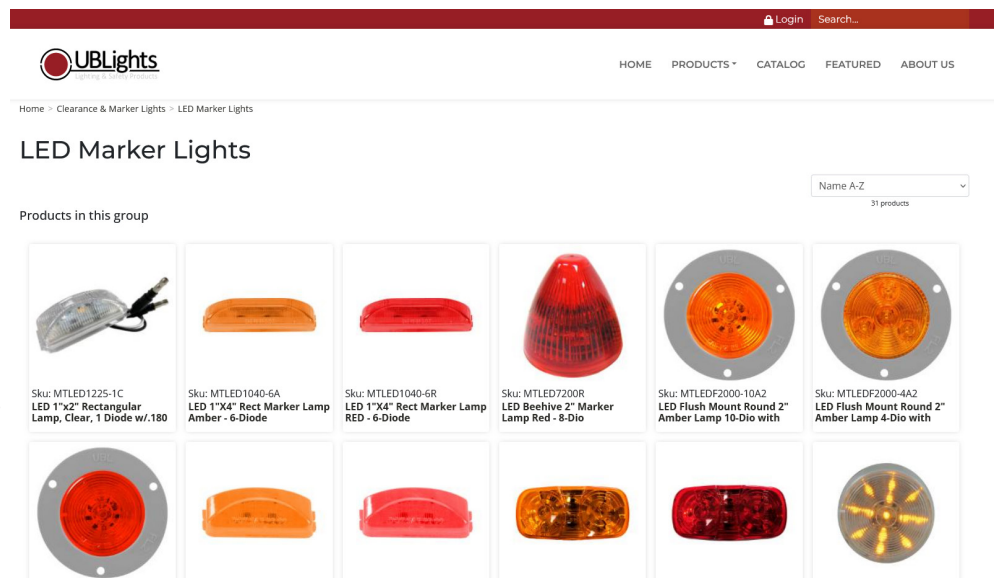

Contact us today to get set up, and then order whenever you like, from anywhere in the world!







TABLE OF CONTENTS

| | | | |
|---------------------------------------------------|-----------|-------------------------------------------------|-----------|
| LED Lights | 1 | Rectangular Stop/Turn/Tail/Back-Up Lights | 48 |
| Oval Stop/Tail/Turn/Back Up Lights..... | 1 | Round Clearance Marker Lights | 48 |
| Rectangular Clearance Marker Lights..... | 4 | Round Clearance Marker Lights, Reflex | 49 |
| Rectangular Clearance Marker Lights, Reflex | 6 | Round Stop/Tail/Turn/Back Up Lights..... | 50 |
| Rectangular Stop/Tail/Turn/Back Up | 7 | Trailer Modules | 51 |
| Round Clearance Marker Lights..... | 7 | Trailer Utility Lights..... | 52 |
| Round Clearance Marker Lights, Reflex | 14 | Utility / Dome..... | 54 |
| Round Stop/Tail/Turn/Back Up Lights..... | 16 | | |
| Trailer Modules | 20 | Incandescent Work Lights..... | 55 |
| Utility / Dome Lights | 20 | Halogen | 55 |
| Warning Lights | 21 | Rubber | 55 |
| Warning/Strobe..... | 24 | Sealed Beam..... | 55 |
| Clearance Marker Lights, Other | 26 | Steel Housing..... | 55 |
| Fender Mounted Lights | 26 | | |
| License Lights | 28 | Accessories..... | 57 |
| | | Base Mounts | 57 |
| LED Work Lights..... | 31 | Branch Deflectors | 57 |
| Cube Lights | 31 | Electrical Accessories..... | 58 |
| Magnetic Lights | 31 | Flanges..... | 58 |
| Oval Work Lights | 32 | Grommets..... | 60 |
| Rectangular Work Lights | 32 | Mounting Brackets..... | 61 |
| Rock Lights..... | 33 | Pigtails | 62 |
| Round Work Lights | 34 | Reflectors..... | 65 |
| Safety Lights | 35 | Wire Harnesses | 67 |
| Square Work Lights | 35 | | |
| | | Mirrors | 69 |
| LED Light Bars | 37 | Convex | 69 |
| Double Row..... | 37 | West Coast Mirrors | 70 |
| Signal Lights | 38 | | |
| | | IP Codes | 72 |
| Incandescent Lights | 39 | SAE Lighting Identification Codes..... | 74 |
| Fender Mount Lights..... | 39 | FMVSS Lighting Requirements..... | 76 |
| Kits & Assemblies..... | 39 | Trailers..... | 76 |
| License Lights | 42 | Trucks, Busses, & MPVs..... | 78 |
| License Lights | 43 | | |
| Light Bars..... | 43 | Warranty | 85 |
| Oval Stop/Turn/Tail/Back-Up Lights..... | 43 | | |
| Rectangular Clearance Marker Lights..... | 44 | | |
| Rectangular Clearance Marker Lights, Reflex | 47 | | |
| Round Clearance Marker Lights..... | 48 | | |

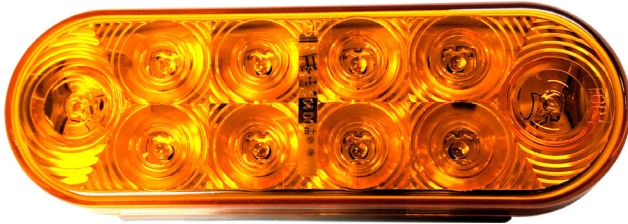

TABLE OF CONTENTS



Oval Stop/Tail/Turn/Back Up Lights

MTLED2238-10A



10 Diode Amber Oval LED Signal / Park Light

LEDs: 10

SAE Code: I6P

Oval Stop/Tail/Turn/Back Up Lights

MTLED2238-10A-AMP

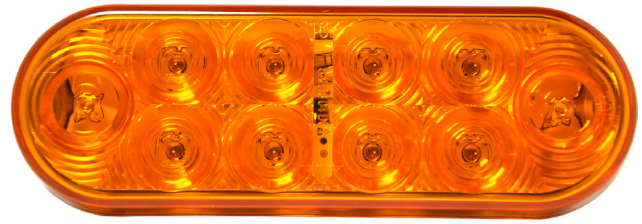

10 Diode Amber Oval LED Signal / Park Light, AMP Connector

LEDs: 10

SAE Code: I6P

Oval Stop/Tail/Turn/Back Up Lights

MTLED2238-10C



10 Diode Clear Oval LED Back-Up Light

LEDs: 10

SAE Code: R2

Oval Stop/Tail/Turn/Back Up Lights

MTLED2238-10R



10 Diode Red Oval LED Stop / Tail / Turn Light

LEDs: 10

SAE Code: S2T216

Oval Stop/Tail/Turn/Back Up Lights

MTLED2238-10R-AMP

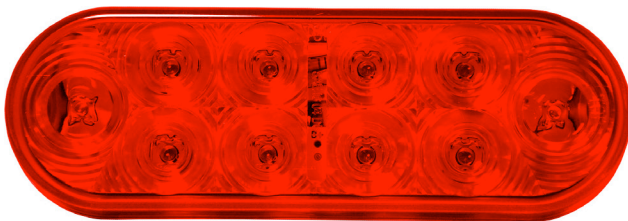

10 Diode Red Oval LED Stop / Tail / Turn Light, AMP Connector

LEDs: 10

SAE Code: S2T216

Oval Stop/Tail/Turn/Back Up Lights

MTLED2238-13R



13 Diode Red Oval LED Stop / Tail / Turn Light

LEDs: 13

SAE Code: STI



Oval Stop/Tail/Turn/Back Up Lights

MTLED2238-1C



6" Oval 1 Diode Clear LED Back-Up Light

LEDs: 1

SAE Code: R2

Oval Stop/Tail/Turn/Back Up Lights

MTLED2238-1R

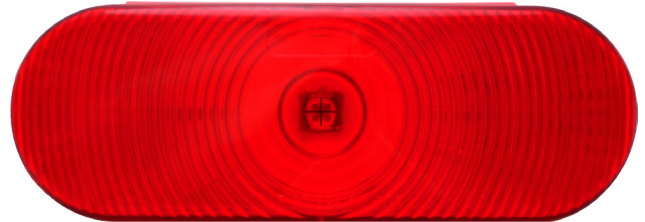

1 Diode Red Oval LED Stop / Tail / Turn Light

LEDs: 1

SAE Code: STIP

Oval Stop/Tail/Turn/Back Up Lights

MTLED2238-24A



24 Diode Amber Oval LED Turn Signal / Park Light

LEDs: 24

SAE Code: IP

Oval Stop/Tail/Turn/Back Up Lights

MTLED2238-24C



24 Diode Clear Oval LED Back-Up Light

LEDs: 24

SAE Code: R2

Oval Stop/Tail/Turn/Back Up Lights

MTLED2238-24R



24 Diode Red Oval LED Stop / Tail / Turn Light

LEDs: 24

SAE Code: STIP

Oval Stop/Tail/Turn/Back Up Lights

MTLED2238-6A

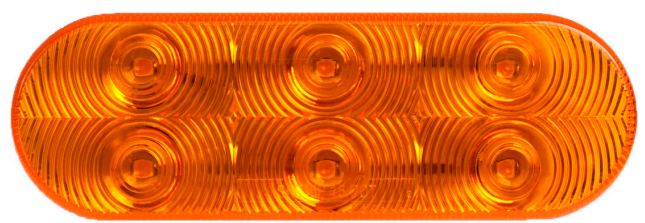

2" x 6" 6 Diode Amber LED Sealed Turn Signal Light

LEDs: 6

SAE Code: I6P



Oval Stop/Tail/Turn/Back Up Lights

MTLED2238-6C

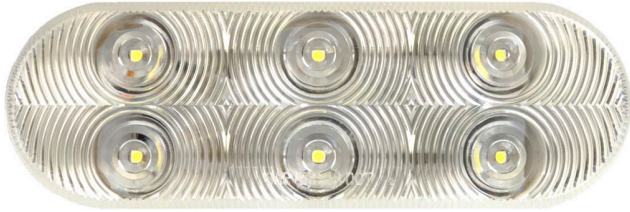

6" Oval 6 Diode Clear LED Back-Up Light

LEDs: 6

SAE Code: 2R

Oval Stop/Tail/Turn/Back Up Lights

MTLED2238-6R

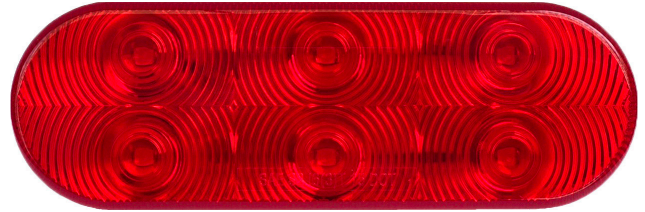

6" Oval 6 Diode Sealed Red LED Stop / Tail / Turn Light

LEDs: 6

SAE Code: S216(3)T

Oval Stop/Tail/Turn/Back Up Lights

MTLED2238-7R

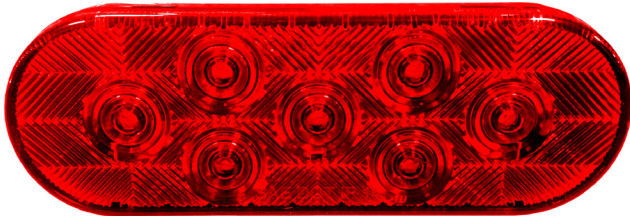

6" Oval 7 Diode Sealed Red LED Stop / Tail / Turn Light

LEDs: 7

SAE Code: S216(3)T

Oval Stop/Tail/Turn/Back Up Lights

MTLED2238C-10R



10 Diode Red w/Clear Lens Oval LED Stop / Tail / Turn Light

LEDs: 10

SAE Code: S2T216

Oval Stop/Tail/Turn/Back Up Lights

MTLED2238C-24A



24 Diode Amber Oval w/Clear Lens LED Turn Signal / Park Light

LEDs: 24

SAE Code: IP

Oval Stop/Tail/Turn/Back Up Lights

MTLED2238CB-12R16C

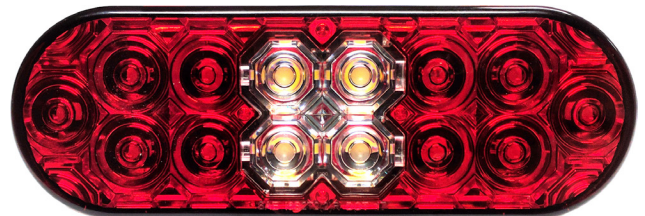

6" Oval 12 Diode Red LED Stop / Tail / Turn Light w/16 Diode Clear Back-Up Light

LEDs: 14 Red / 16 White

SAE Code: I6 S2 T2 (2)R



Oval Stop/Tail/Turn/Back Up Lights

MTLEDF2238-24A1



2" x 6" Oval 24 Diode Amber LED Flush Mount Signal / Park Light w/Black Flange

LEDs: 24

SAE Code: IP

Oval Stop/Tail/Turn/Back Up Lights

MTLEDF2238-24R1



2" x 6" Oval 24 Diode Red LED Flush Mount Stop / Tail / Turn w/Black Flange

LEDs: 24

SAE Code: STIP

Oval Stop/Tail/Turn/Back Up Lights

MTLEDSF2238-10A



2" x 6" Oval 10 Diode Amber LED Surface Mount Turn Signal Light, Hardwired w/ Black Flange

LEDs: 10

SAE Code: I6P

Oval Stop/Tail/Turn/Back Up Lights

MTLEDSF2238-10R



2" x 6" Oval 10 Diode Red LED Stop / Tail / Turn Light, Hardwired w/ Black Flange

LEDs: 10

SAE Code: S2T2I6

Rectangular Clearance Marker Lights

MTLED0750-6A

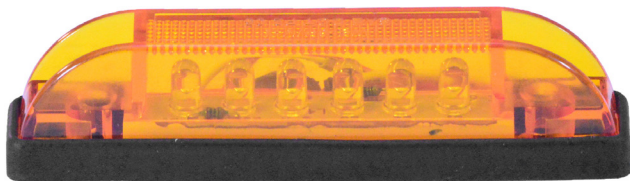

.75" x 4" 6 Diode Amber LED Slimline Marker Light

LEDs: 6

SAE Code: P2

Rectangular Clearance Marker Lights

MTLED0750-6R

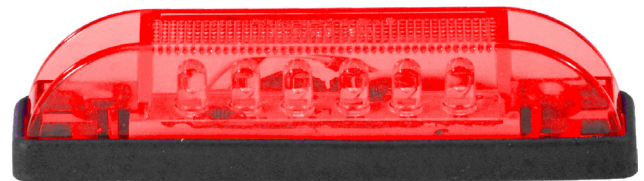

.75" x 4" 6 Diode Red LED Slimline Marker Light

LEDs: 6

SAE Code: P2



Rectangular Clearance Marker Lights

MTLED0750A

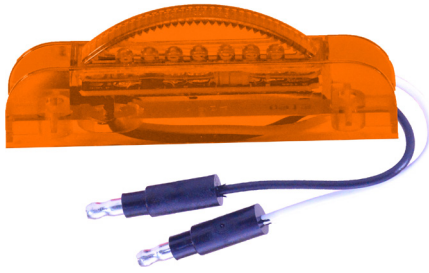

.75" x 4" 7 Diode Amber LED Slimline Marker Light

LEDs: 7

SAE Code: P2

Rectangular Clearance Marker Lights

MTLED0750R

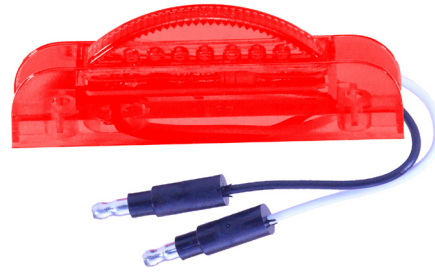

.75" x 4" 7 Diode Red LED Slimline Marker Light

LEDs: 7

SAE Code: P2

Rectangular Clearance Marker Lights

MTLED1040-6A

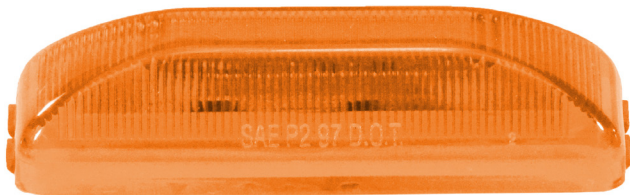

1" x 4" Rectangular 6 Diode Amber LED Marker Light

LEDs: 6

SAE Code: P2

Rectangular Clearance Marker Lights

MTLED1040-6R

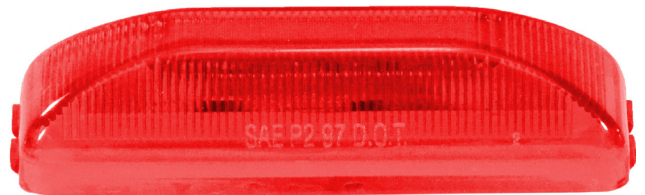

1" x 4" Rectangular 6 Diode Red LED Marker Light

LEDs: 6

SAE Code: P2PC

Rectangular Clearance Marker Lights

MTLED1225-1C



1" x 2" Rectangular 1 Diode Clear LED Marker Light
w/.180 Bullet Connector

LEDs: 1

SAE Code: P2

Rectangular Clearance Marker Lights

MTLED1225-3A

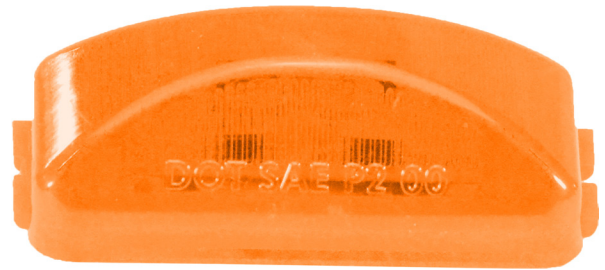

1" x 2" Rectangular 3 Diode Amber LED Marker Light

LEDs: 3

SAE Code: P2PC



Rectangular Clearance Marker Lights

MTLED1225-3R

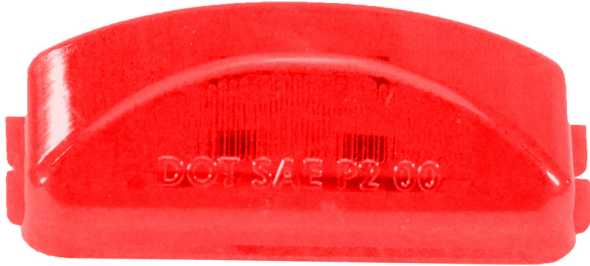

1" x 2" Rectangular 3 Diode Red LED Marker Light

LEDs: 3
SAE Code: P2PC

Rectangular Clearance Marker Lights

MTLED2040A

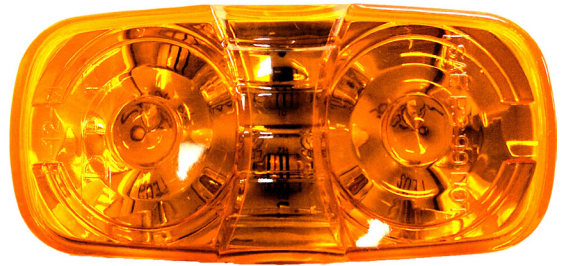

2" x 4" Rectangular 10 Diode Amber LED Marker Light, Bullseye Pattern

LEDs: 10
SAE Code: P2PC

Rectangular Clearance Marker Lights

MTLED2040R



2" x 4" Rectangular 10 Diode Red LED Marker Light, Bullseye Pattern

LEDs: 10
SAE Code: P2PC

Rectangular Clearance Marker Lights, Reflex

MTLR2030-1A



2" x 2.75" Rectangular 1 Diode Amber LED Marker Light, Sealed, Surface Mount, Reflective Lens

LEDs: 1
SAE Code: AP2

Rectangular Clearance Marker Lights, Reflex

MTLR2030-1R

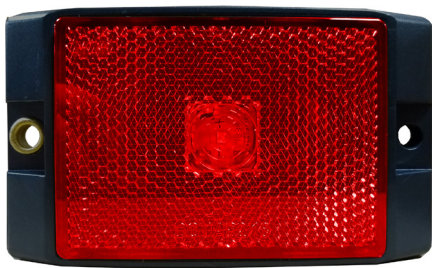

2" x 2.75" Rectangular 1 Diode Red LED Marker Light, Sealed, Surface Mount, Reflective Lens

LEDs: 1
SAE Code: AP2

Rectangular Clearance Marker Lights, Reflex

MTLR2060-8A

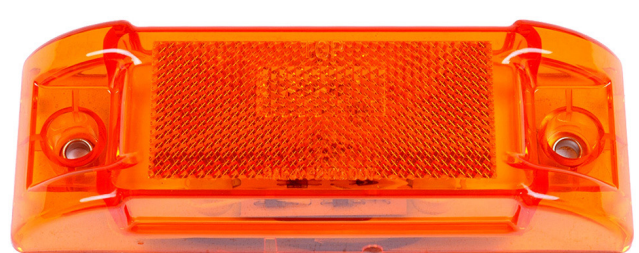

2" x 6" Rectangular 8 Diode Amber LED Side Marker Light, Reflective Lens

LEDs: 8
SAE Code: AP2



Rectangular Clearance Marker Lights, Reflex

MTLR2060-8R



2" x 6" Rectangular 8 Diode Red LED Side Marker Light, Reflective Lens

LEDs: 8

SAE Code: AP2

Rectangular Clearance Marker Lights, Reflex

MTLR2238-28A



28 Diode Amber LED Mid-Turn Signal Light, Reflective, SAE J2039, AEP2

LEDs: 28

SAE Code: AEP2

Rectangular Clearance Marker Lights, Reflex

MTLR2238-9A



9 Diode Amber LED Mid-Turn Signal Light, Reflective

LEDs: 9

SAE Code: AE2P2

Rectangular Stop/Tail/Turn/Back Up

MTLED4060-24A



4" x 6" Rectangular 24 Diode Amber LED Signal / Park / Clearance Light

LEDs: 24

SAE Code: I6PP2

Rectangular Stop/Tail/Turn/Back Up

MTLED4060-24R

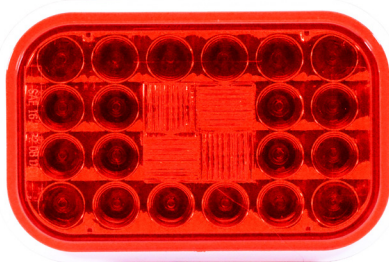

4" x 6" Rectangular 24 Diode Red LED Stop / Tail / Turn

LEDs: 24

SAE Code: I6P2 S2(3)T

Round Clearance Marker Lights

MTLED0700A



.75" Round Single Diode Amber LED Side Marker Light w/Grommet

LEDs: 1

SAE Code: PC



Round Clearance Marker Lights

MTLED0700A-BLT



.75" Round Single Diode Amber LED Side Marker Light w/Grommet & Bullet Connector

LEDs: 1

SAE Code: PC

Round Clearance Marker Lights

MTLED0700ADF-BLT



.75" Round 3 Diode Amber LED Dual Function Side Marker Light w/Grommet & 3 Wire 180 Bullet Connector

LEDs: 3

SAE Code: P2PC

Round Clearance Marker Lights

MTLED0700C



.75" Round Single Clear Diode LED Side Marker Light w/ Grommet

LEDs: 1

Round Clearance Marker Lights

MTLED0700C-BLT



.75" Round Single Clear Diode LED Side Marker Light w/ Grommet & Bullet Connector

LEDs: 1

SAE: PC

Round Clearance Marker Lights

MTLED0700CA



.75" Round LED Side Marker Light, Single Amber Diode w/Clear Lens w/Grommet

LEDs: 1

SAE: PC

Round Clearance Marker Lights

MTLED0700CA-BLT



.75" Round LED Side Marker Light, Single Amber Diode w/Clear Lens w/Grommet & Bullet Connector

LEDs: 1

SAE: PC



Round Clearance Marker Lights

MTLED0700CB



.75" Round LED Side Marker Light, Single Blue Diode w/ Clear Lens, w/Grommet

LEDs: 1
SAE: PC

Round Clearance Marker Lights

MTLED0700CR



.75" Round LED Side Marker Light, Single Red Diode w/ Clear Lens, w/Grommet

LEDs: 1
SAE: PC

Round Clearance Marker Lights

MTLED0700CR-BLT



.75" Round LED Side Marker Light, Single Red Diode w/ Clear Lens, w/Grommet & Bullet Connector

LEDs: 1
SAE: PC

Round Clearance Marker Lights

MTLED0700R



.75" Round Single Diode Red LED Side Marker Light w/ Grommet

LEDs: 1
SAE: PC

Round Clearance Marker Lights

MTLED0700R-BLT



.75" Round Single Diode Red LED Side Marker Light w/ Grommet & Bullet Connector

LEDs: 1
SAE: PC

Round Clearance Marker Lights

MTLED0700RDF-BLT



.75" Round 3 Diode Red LED Dual Function Side Marker Light w/Grommet & 3 Wire 180 Bullet Connector

LEDs: 3
SAE: P2PC



Round Clearance Marker Lights

MTLED2000-10A



2" Round 10 Diode Amber LED Marker Light

LEDs: 10
SAE: P2

Round Clearance Marker Lights

MTLED2000-10R



2" Round 10 Diode Red LED Marker Light

LEDs: 10
SAE: P2

Round Clearance Marker Lights

MTLED2000-1A



2" Round 1 Diode Amber LED Clearance Marker Light

LEDs: 1
SAE: P2

Round Clearance Marker Lights

MTLED2000-1A-ABS



2" Round 1 Diode Amber LED ABS Brake System Indicator Light, Grommet Mount

LEDs: 1
SAE: P2

Round Clearance Marker Lights

MTLED2000-1R



2" Round 1 Diode Red LED Clearance Marker Light

LEDs: 1
SAE: P2

Round Clearance Marker Lights

MTLED2000-4A



2" Round 4 Diode Amber LED Marker Light

LEDs: 4
SAE: P2



Round Clearance Marker Lights

MTLED2000-4R



2" Round 4 Diode Red LED Marker Light

LEDs: 4
SAE: P2

Round Clearance Marker Lights

MTLED2000-9A



2" Round 9 Diode Amber LED Marker Light

LEDs: 9
SAE: P3PC

Round Clearance Marker Lights

MTLED2000-9R



2" Round 9 Diode Red LED Marker Light

LEDs: 9
SAE: P3PC

Round Clearance Marker Lights

MTLED2000C-10A



2" Round 10 Diode Amber w/Clear Lens LED Marker Light

LEDs: 10
SAE: P2

Round Clearance Marker Lights

MTLED2000C-10R



2" Round 10 Diode Red w/Clear Lens LED Marker Light

LEDs: 10
SAE: P2

Round Clearance Marker Lights

MTLED2500-12A

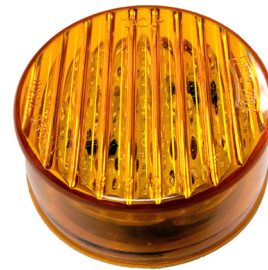

2.5" Round 12 Diode Amber LED Marker Light

LEDs: 12
SAE: P2P3



Round Clearance Marker Lights

MTLED2500-12R



2.5" Round 12 Diode Red LED Marker Light

LEDs: 12
SAE: P2P3

Round Clearance Marker Lights

MTLED2500-13A



2.5" Round 13 Diode Amber LED Marker Light

LEDs: 13
SAE: P2

Round Clearance Marker Lights

MTLED2500-13R



2.5" Round 13 Diode Red LED Marker Light

LEDs: 13
SAE: P2

Round Clearance Marker Lights

MTLED2500-2A-ABS



2.5" Round 2 Diode Amber LED ABS Brake System Indicator Light, w/Grommet Mount

LEDs: 2
SAE: P2

Round Clearance Marker Lights

MTLED2500-4A



2.5" Round 4 Diode Amber LED Marker Light

LEDs: 4
SAE: P2

Round Clearance Marker Lights

MTLED2500-4R



2.5" Round 4 Diode Red LED Marker Light

LEDs: 4
SAE: P2



Round Clearance Marker Lights

MTLED2500C-13A



2.5" Round 13 Diode Amber w/Clear Lens LED Marker Light

LEDs: 13
SAE: P2

Round Clearance Marker Lights

MTLED2500C-13R



2.5" Round 13 Diode Red w/Clear Lens LED Marker Light

LEDs: 13
SAE: P2

Round Clearance Marker Lights

MTLEDF2000-1A-ABS



2" Round 1 Diode Amber LED ABS Brake System Indicator Light, Sonically Welded, Recess Mount

LEDs: 1
SAE: P2

Round Clearance Marker Lights

MTLEDF2500-2A-ABS



2.5" Round 2 Diode Amber LED ABS Brake System Indicator Light, Sonically Welded, Recess Mount

LEDs: 2
SAE: P2

Round Clearance Marker Lights

MTLEDS2000-1A-ABS



2" Round 1 Diode Amber LED ABS Brake System Indicator Light, Sonically Welded, Surface Mount

LEDs: 1
SAE: P2

Round Clearance Marker Lights

MTLEDS2500-2A-ABS



2.5" Round 2 Diode Amber LED ABS Brake System Indicator Light, Sonically Welded, Surface Mount

LEDs: 2
SAE: P2



Round Clearance Marker Lights, Reflex

MTLEDR2500-1A



2.5" Round 1 Diode Amber LED Marker Light, Reflective Lens

LEDs: 1
SAE: AP2

Round Clearance Marker Lights, Reflex

MTLEDR2500-1R



2.5" Round 1 Diode Red LED Marker Light, Reflective Lens

LEDs: 1
SAE: AP2

Round Clearance Marker Lights, Reflex

MTLEDRF2000-1A-AMP



2" Round 1 Diode Amber LED Marker Light, Reflective Flange, AMP Connection

LEDs: 1
SAE: AP2

Round Clearance Marker Lights, Reflex

MTLEDRF2000-1AC

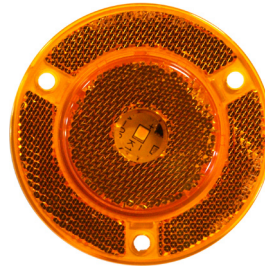

2" Round 1 Diode Amber LED Marker Light, Reflective Flange, Pigtail Securing Clip

LEDs: 1
SAE: AP2

Round Clearance Marker Lights, Reflex

MTLEDRF2000-1AH

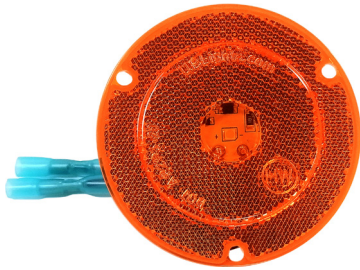

2" Round 1 Diode Amber LED Marker Light, Reflective Flange, Hardwired w/Blue Butt Connect

LEDs: 1
SAE: AP2

Round Clearance Marker Lights, Reflex

MTLEDRF2000-1R-AMP

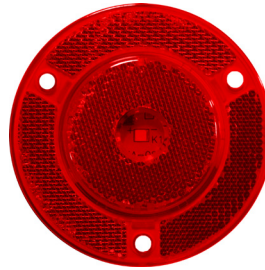

2" Round 1 Diode Red LED Marker Light, Reflective Flange, AMP Connection

LEDs: 1
SAE: AP2



Round Clearance Marker Lights, Reflex

MTLEDRF2000-1RC



2" Round 1 Diode Red LED Marker Light, Reflective Flange, Pigtail Securing Clip

LEDs: 1
SAE: AP2

Round Clearance Marker Lights, Reflex

MTLEDRF2000-1RH

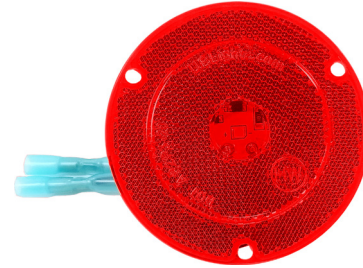

2" Round 1 Diode Red LED Marker Light, Reflective Flange, Hardwired w/Blue Butt Connect

LEDs: 1
SAE: AP2

Round Clearance Marker Lights, Reflex

MTLEDRF2500-1A-AMP

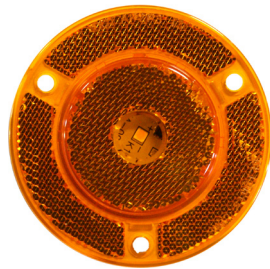

2.5" Round 1 Diode Amber LED Marker Light, Reflective Flange, AMP Connection

LEDs: 1
SAE: AP2

Round Clearance Marker Lights, Reflex

MTLEDRF2500-1AC

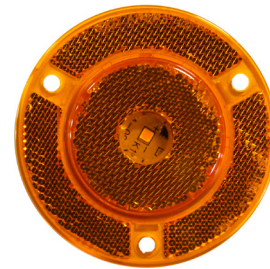

2.5" Round 1 Diode Amber LED Marker Light, Reflective Flange, Pigtail Securing Clip

LEDs: 1
SAE: AP2

Round Clearance Marker Lights, Reflex

MTLEDRF2500-1AH

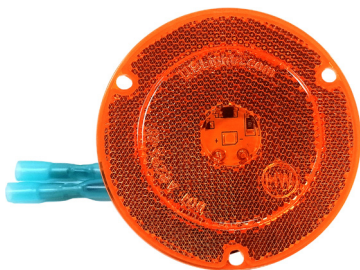

2.5" Round 1 Diode Amber LED Marker Light, Reflective Flange, Hardwired w/Blue Butt Connect

LEDs: 1
SAE: AP2

Round Clearance Marker Lights, Reflex

MTLEDRF2500-1R-AMP



2.5" Round 1 Diode Red LED Marker Light, Reflective Flange, AMP Connection

LEDs: 1
SAE: AP2



Round Clearance Marker Lights, Reflex

MTLEDRF2500-1RC

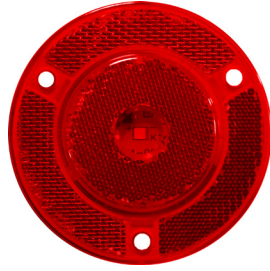

2.5" Round 1 Diode Red LED Marker Light, Reflective Flange, Pigtail Securing Clip

LEDs: 1
SAE: AP2

Round Clearance Marker Lights, Reflex

MTLEDRF2500-1RH

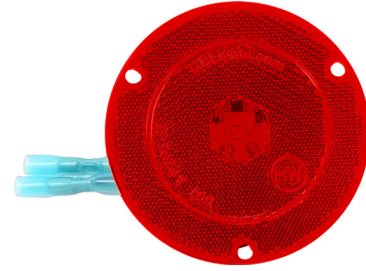

2.5" Round 1 Diode Red LED Marker Light, Reflective Flange, Hardwired, Blue Butt Connector

LEDs: 1
SAE: AP2

Round Clearance Marker Lights, Reflex

MTLR2500-4A



2.5" Round 4 Diode Amber LED Clearance Marker Light, Reflective

LEDs: 4
SAE: AP2

Round Clearance Marker Lights, Reflex

MTLR2500-4R



2.5" Round 4 Diode Red LED Clearance Marker Light, Reflective

LEDs: 4
SAE: AP2

Round Stop/Tail/Turn/Back Up Lights

MTLED4000-10A



4" Round 10 Diode Amber LED Turn Signal / Parking Light

LEDs: 10
SAE: I6P

Round Stop/Tail/Turn/Back Up Lights

MTLED4000-10C



4" Round 10 Diode Clear LED Back-Up Light

LEDs: 10
SAE: R2



Round Stop/Tail/Turn/Back Up Lights

MTLED4000-10R



4" Round 10 Diode Red LED Stop / Tail / Turn Light

LEDs: 10
SAE: S2T216

Round Stop/Tail/Turn/Back Up Lights

MTLED4000-10R-1



4" Round 10 Diode Sealed Red LED Stop / Tail / Turn Light, AMP Connection

LEDs: 10
SAE: S2T216

Round Stop/Tail/Turn/Back Up Lights

MTLED4000-12A



4" Round 12 Diode Amber LED Turn Signal / Parking Light

LEDs: 12
SAE: I6P

Round Stop/Tail/Turn/Back Up Lights

MTLED4000-12R



4" Round 12 Diode Red LED Stop / Tail / Turn Light

LEDs: 12
SAE: STI

Round Stop/Tail/Turn/Back Up Lights

MTLED4000-1C



4" Round 1 Diode Clear LED Back-Up Light

LEDs: 1
SAE: R2

Round Stop/Tail/Turn/Back Up Lights

MTLED4000-24A



4" Round 24 Diode Amber LED Turn Signal / Parking Light

LEDs: 24
SAE: IP



Round Stop/Tail/Turn/Back Up Lights

MTLED4000-24C



4" Round 24 Diode Clear LED Back-Up Light

LEDs: 24
SAE: R2

Round Stop/Tail/Turn/Back Up Lights

MTLED4000-24R

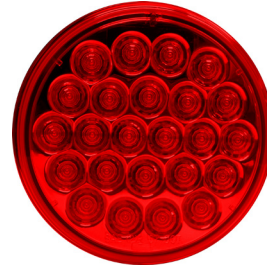

4" Round 24 Diode Red LED Stop / Tail / Turn Light

LEDs: 24
SAE: STI

Round Stop/Tail/Turn/Back Up Lights

MTLED4000-40A



4" Round 40 Diode Amber LED Turn Signal / Parking Light

LEDs: 40
IP: IPx6
SAE: I6P

Round Stop/Tail/Turn/Back Up Lights

MTLED4000-40R-1

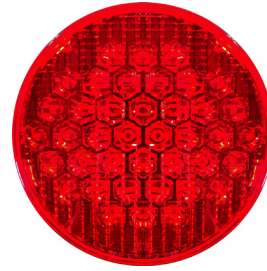

4" Round 40 Diode Red LED Sealed Stop / Tail / Turn Light

LEDs: 40
SAE: STI

Round Stop/Tail/Turn/Back Up Lights

MTLED4000-6A

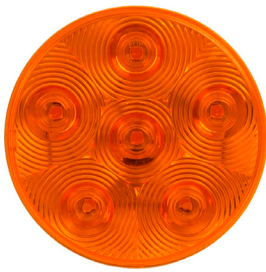

4" Round 6 Diode Amber LED Dual Function Light

LEDs: 6
SAE: I6P

Round Stop/Tail/Turn/Back Up Lights

MTLED4000-7C



4" Round 7 Diode LED Back-Up Light

LEDs: 7
SAE: 2R



Round Stop/Tail/Turn/Back Up Lights

MTLED4000-7R



4" Round 7 Diode Red LED Stop / Tail / Turn Light

LEDs: 7
SAE: S216(3)T

Round Stop/Tail/Turn/Back Up Lights

MTLED4000C-24R



4" Round 24 Diode Red LED w/Clear Lens Stop / Tail / Turn

LEDs: 24
SAE: STI

Round Stop/Tail/Turn/Back Up Lights

MTLED4000CB-12R16C



4" Round 12 Diode Red / 16 Diode Clear LED Combination Stop / Tail / Turn / Back-Up Light

LEDs: 12 Red / 16 White
SAE: I6 S2 T2 (2)R

Round Stop/Tail/Turn/Back Up Lights

MTLED7000-17A



7" Round 17 Diode Amber LED Bus Light, Single Function, Reflex Lens

LEDs: 17
SAE: I6P2A

Round Stop/Tail/Turn/Back Up Lights

MTLEDF4000-1R2



4" Round 1 Diode Red LED Flush Mount Stop / Tail / Turn Light w/Gray Flange, & Pigtail Securing Clip

LEDs: 1
SAE: STI

Round Stop/Tail/Turn/Back Up Lights

MTLEDF4000-1R2-AMP



4" Round 1 Diode Red LED Flush Mount Stop / Tail / Turn Light w/Gray Flange, & AMP Connector

LEDs: 1
SAE: STI



Round Stop/Tail/Turn/Back Up Lights

MTLEDF4000-1R2H



4" Round 1 Diode Red LED Flush Mount Stop / Tail / Turn Light, Hardwired w/Gray Flange

LEDs: 1
SAE: STI

Trailer Modules

MTTM9012L



Road-Side Trailer Module, 2 Hole w/LED Side Marker & 6 Diode LED Tail Lights

SAE: S2T2I6 / P2PC / A

Trailer Modules

MTTM9012R



Curb-Side Trailer Module, 2 Hole w/LED Side Marker & 6 Diode LED Tail Lights

SAE: S2T2I6 / P2PC / A

Trailer Utility Lights

MTLTL6400



16 Diode Universal Submersable LED Stop / Tail / Turn / Back-Up Light w/License Light & Rear Reflector

LEDs: 16 Tail / 18 Backup / 4 License
SAE: A16L2RS2(3)T

Utility / Dome Lights

MTLDL3060-12C



3" x 6" Rectangular LED Utility / Dome Light, Surface Mount w/2 6" Wire Leads

LEDs: 12

Utility / Dome Lights

MTLDL60180-48



48 Diode Hardwired LED Dome Light, 850 Lumens, 12 Volts

LEDs: 48



Warning Lights

MTKTLEDW2238-24A



2" x 6" Oval 24 Diode Amber Class 2 Warning Strobe Light, w/Pigtail & Grommet

LEDs: 24
SAE: R2

Warning Lights

MTKTLEDW2238-24R



2" x 6" Oval 24 Diode Red Class 2 Warning Strobe Light, w/Pigtail & Grommet

LEDs: 24
SAE: R2

Warning Lights

MTLEDM4065-18A

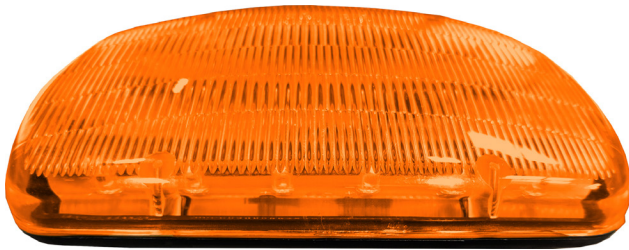

4" x 6.5" Rectangular 18 Diode Amber LED Warning Light w/Magnetic Back

LEDs: 18
SAE: T

Warning Lights

MTLEDM4065-18R



4" x 6.5" Rectangular 18 Diode Red LED Warning Light w/Magnetic Back

LEDs: 18
SAE: T

Warning Lights

MTLEDW1030-3CA



1" x 3" Rectangular 4 Diode Amber Mini Strobe Light w/ Clear Lens, SAE J595 Class 1

LEDs: 3
IP: IP68
SAE: J595 Class II

Warning Lights

MTLEDW1030-3CB

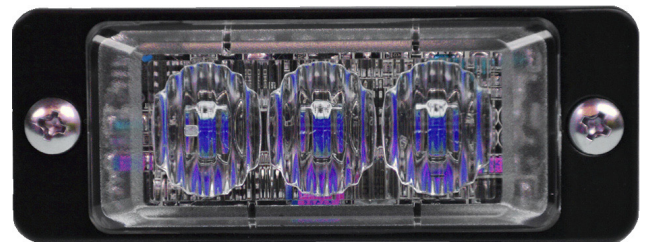

1" x 3" Rectangular 4 Diode Blue Mini Strobe Light w/ Clear Lens, SAE J595 Class 1

LEDs: 4
IP: IP68
SAE: J595 Class II



Warning Lights

MTLEDW1030-3CR

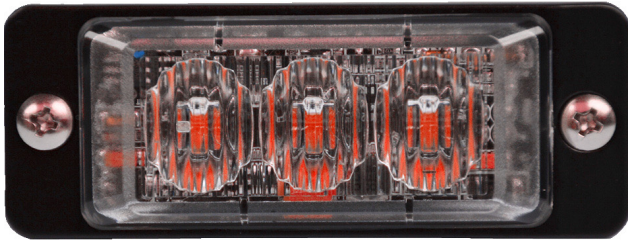

1" x 3" Rectangular 4 Diode Red Mini Strobe Light w/
Clear Lens, SAE J595 Class 1

LEDs: 3
IP: IP68
SAE: J595 Class II

Warning Lights

MTLEDW1030-3CW

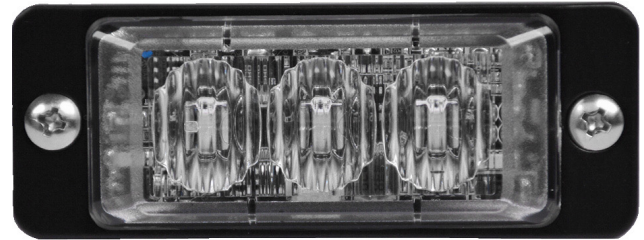

1" x 3" Rectangular 4 Diode White Mini Strobe Light w/
Clear Lens, SAE J595 Class 1

LEDs: 3
IP: IP68
SAE: J595 Class II

Warning Lights

MTLEDW1035-4CA

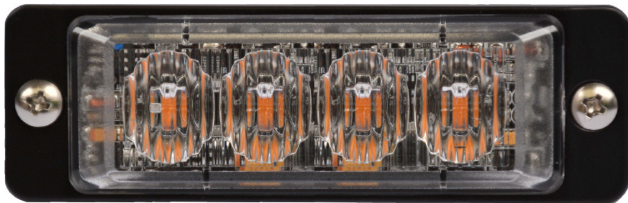

1" x 3.5" Rectangular 4 Diode Amber Mini Strobe Light
w/Clear Lens, SAE J595 Class 1

LEDs: 4
IP: IP68
SAE: J595 Class I

Warning Lights

MTLEDW1035-4CR

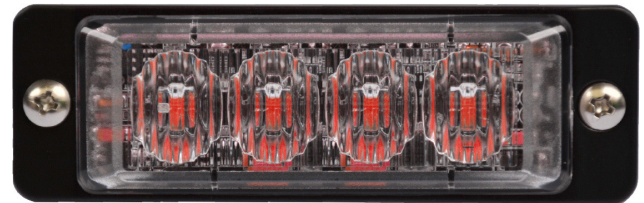

1" x 3.5" Rectangular 4 Diode Red Mini Strobe Light w/
Clear Lens, SAE J595 Class 1

LEDs: 4
IP: IP68
SAE: J595 Class I

Warning Lights

MTLEDW1035-4CW

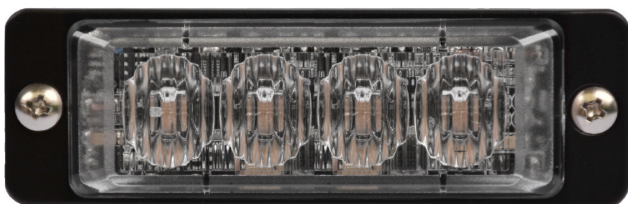

1" x 3.5" Rectangular 4 Diode White Mini Strobe Light w/
Clear Lens, SAE J595 Class 1

LEDs: 4
IP: IP68
SAE: J595 Class I

Warning Lights

MTLEDW1040-4CA



1" x 4" Rectangular 4 Diode Amber Mini Strobe Light w/
Clear Lens, SAE J595 Class 1

LEDs: 4
IP: IP68
SAE: J595 Class I



Warning Lights

MTLEDW1040-4CAW



1" x 4" Rectangular 4 Diode Amber Mini Strobe Light w/
Wide Angle Clear Lens, SAE J595 Class 1

LEDs: 4
IP: IP68
SAE: J595 Class I

Warning Lights

MTLEDW1040-4CB



1" x 4" Rectangular 4 Diode Blue Mini Strobe Light w/
Clear Lens, SAE J595 Class 1

LEDs: 4
IP: IP68
SAE: J595 Class I

Warning Lights

MTLEDW1040-4CR



1" x 4" Rectangular 4 Diode Red Mini Strobe Light w/
Clear Lens, SAE J595 Class 1

LEDs: 4
IP: IP68
SAE: J595 Class I

Warning Lights

MTLEDW1040-4CWW



1" x 4" Rectangular 4 Diode White Mini Strobe Light w/
Wide Angle Clear Lens, SAE J595 Class 1

LEDs: 4
IP: IP68
SAE: J595 Class I

Warning Lights

MTLEDW1045-6CA



1" x 4.5" Rectangular 6 Diode Amber Mini Strobe Light
w/Clear Lens, SAE J595 Class 1

LEDs: 6
IP: IP68
SAE: J595 Class I

Warning Lights

MTLEDW1045-6CWA

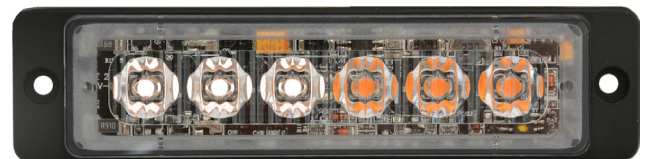

1" x 4.5" Rectangular 3 Amber & 3 White Diodes Mini
Strobe Light w/Clear Lens, SAE J595 Class 1

LEDs: 6
IP: IP68
SAE: J595 Class I



Warning/Strobe

MTLEDW1045-6CR

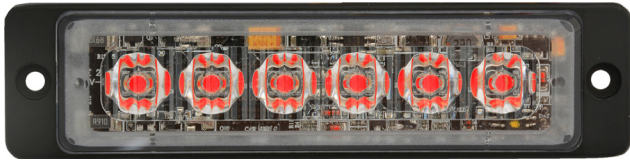

1" x 4.5" Rectangular Red LED Mini Strobe Warning Light, Clear Lens, 12-24 Volts, IP68, SAE J595 Class 1

LEDs: 6
IP: IP68
SAE: J595 Class I

Warning/Strobe

MTLEDW1045-6CW



1" x 4.5" Rectangular White LED Mini Strobe Warning Light, Clear Lens, 12-24 Volts, IP68, SAE J595 Class 1

LEDs: 6
IP: IP68
SAE: J595 Class I

Warning Lights

MTLEDW2238-24A

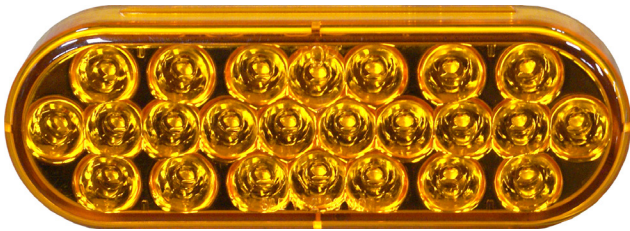

2" x 6" Oval 24 Diode Amber Warning Strobe Light

LEDs: 24
SAE: IP

Warning Lights

MTLEDW2238-24R

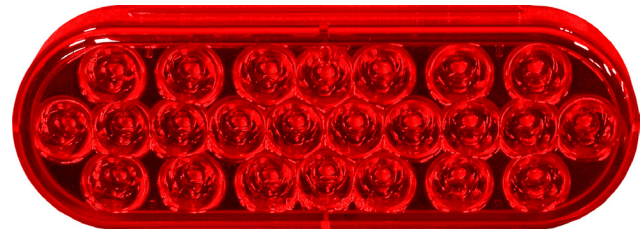

2" x 6" Oval 24 Diode Red Warning Strobe Light

LEDs: 24
SAE: STIP

Warning Lights

MTLEDW2525-4A-6AW



Square 4 Diode Amber LED Warning Light & 6 Diode Amber / White Position Light, 20 Flash Modes, IP67, SAE Class 1

LEDs: 4 Amber / 6 Amber/White
IP: IP67
SAE: Class 1

Warning Lights

MTLEDW4000-24A



4" Round 24 Diode Amber LED Warning Strobe Light

LEDs: 24
SAE: IP



Warning Lights

MTLSL3050-3A



3.5" x 5" 3 Diode Amber LED Strobe Light, Hardwired, 36 Flashes /Minute, 12-110 Volt

LEDs: 3
IP: IP66
SAE: Class 3

Warning Lights

MTLSL3755-6A

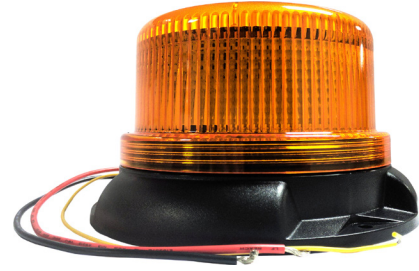

3.75" x 5" 6 Diode Amber LED Strobe Light, Hardwired, 2X/3X/4X Flash, 12-24 Volt, SAE Class 1

LEDs: 6
IP: IP66
SAE: Class 1

Warning Lights

MTLSL4012-3-AF



LED Individual Warning Flare, 12 Amber Diodes, 3 White Diodes, Magnetic, 9 Flash Patterns, Uses 3 AAA Batteries

LEDs: 12 + 3
IP: IP67

Warning Lights

MTLSL5030-3A



3.8" x 5" 3 Diode Amber LED Strobe Light, Hardwired, 36 Flashes /Minute, 12-110 Volt, SAE Class 3

LEDs: 5
IP: IP66
SAE: Class 3

Warning Lights

MTLSL5050-8A



5" x 5.25" 8 Diode Amber LED Rotating Beacon Light, Hardwired, 120 Flashes /Minute, 12-40 Volt, SAE Class 2

LEDs: 8
IP: IP66
SAE: Class 2

Warning Lights

MTLSLM3050-3A



3.5" x 5" 3 Diode Amber LED Strobe Light, Magnetic Base, 50 Flashes /Minute, 12-110 Volt, IP66, SAE Class 3

LEDs: 3
IP: IP66
SAE: Class 3



Clearance Marker Lights, Other

MTLED7200R



2" Beehive 8 Diode Red LED Marker Light

LEDs: 8
SAE: P2

Fender Mounted Lights

MTLFM4102-21RA



24 Diode Round Red/Amber LED Fender Mount w/ Chrome Die Cast Base

LEDs: 24 Amber / 24 Red
SAE: I6P2 S2(3)T16

Kits & Assemblies

MTKTL2000-10A



2" Round 10 Diode Amber LED Light Kit w/Open Grommet & Pigtail

LEDs: 10
SAE: P2

Kits & Assemblies

MTKTL2000-10R



2" Round 10 Diode Red LED Light Kit w/Open Grommet & Pigtail

LEDs: 10
SAE: P2

Kits & Assemblies

MTKTL2000-4A



2" Round 4 Diode Amber LED Light Kit w/Open Grommet & Pigtail

LEDs: 4
SAE: P2

Kits & Assemblies

MTKTL2000-4R



2" Round 4 Diode Red LED Light Kit w/Open Grommet & Pigtail

LEDs: 4
SAE: P2



Kits & Assemblies

MTKTL2001-9A



2" Round 9 Diode Amber LED Light Kit w/Closed Grommet & Pigtail

LEDs: 9
SAE: P3PC

Kits & Assemblies

MTKTL2001-9R



2" Round 9 Diode Red LED Light Kit w/Closed Grommet & Pigtail

LEDs: 9
SAE: P3PC

Kits & Assemblies

MTKTL2238-10A



Oval 10 Diode Amber LED Light Kit w/Open Grommet & Pigtail

LEDs: 10
SAE: S2T2I6

Kits & Assemblies

MTKTL2238-10R



Oval 10 Diode Red LED Light Kit w/Open Grommet & Pigtail

LEDs: 10
SAE: S2T2I6

Kits & Assemblies

MTKTL2238-24C



Oval 24 Diode Clear LED Light Kit w/Open Grommet & Pigtail

LEDs: 24
SAE: R2

Kits & Assemblies

MTKTL2238C-10R



Oval 10 Diode Red LED Light Kit, Clear Lens w/Open Grommet & Pigtail

LEDs: 10
SAE: S2T2I6



Kits & Assemblies

MTKTL4000-10A



4" Round 10 Diode Amber LED Light Kit w/Open Grommet & Pigtail

LEDs: 10

SAE: I6P

Kits & Assemblies

MTKTL4000-10R



4" Round 10 Diode Red LED Kit w/Open Grommet & Pigtail

LEDs: 10

SAE: I6P

Kits & Assemblies

MTKTL4000-12R



4" 12 Diode Round Red LED Light Kit w/Open Grommet & Pigtail

LEDs: 12

SAE: STI

Kits & Assemblies

MTKTL4000-12R



4" Round 12 Diode Red LED Light Kit w/Open Grommet & Pigtail

LEDs: 12

SAE:

License Lights

MTLLP1225-2C

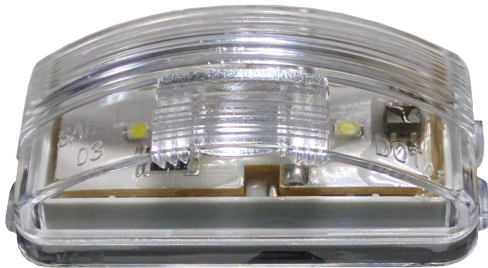

1" x 2" 2 Diode LED License Plate Light, Sealed

LEDs: 2

SAE: L

License Lights

MTLLP1225C-2

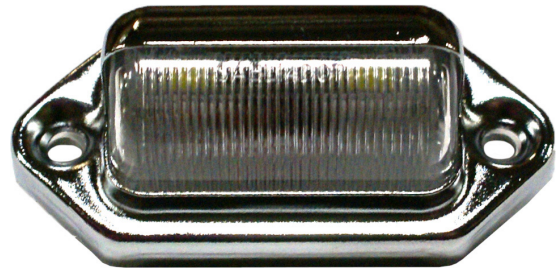

2 Diode LED License Light, Chrome Housing, Ring Terminal Epoxy Housing

LEDs: 2

SAE: L



License Lights

MTLLP1225C-2-BLT

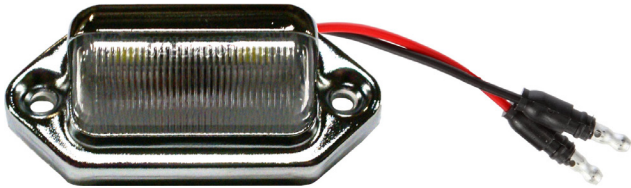

2 Diode LED License Light, Chrome Housing, Ring Terminal Epoxy Housing w/.180 Bullet Connector

LEDs: 2

SAE: L

License Lights

MTLLP3000-2C



2 Diode LED License Light, Chrome Body

LEDs: 2

SAE: L





Cube Lights

MTLW0302-2K



3" x 3" 4 Diode LED Work Light Set, 1680 Lumen Flood Beam, 10-30 Volt, w/18' Deutsch Connector Harness

LEDs: 4 Each
IP: IP67

Cube Lights

MTLW0303-2K



3" x 3" 6 Diode LED Work Light Set, 2520 Lumen Flood Beam, 10-30 Volt, w/18' Deutsch Connector Harness

LEDs: 6 Each
IP: IP67

Cube Lights

MTLW0303-4S



3" x 3" 4 Diode LED Work Light, 1680 Lumen Spot Beam, 10-30 Volt, Female Deutsch Connector

LEDs: 4
IP: IP67

Cube Lights

MTLW0303-6F



3" x 3" 6 Diode LED Work Light, 2520 Lumen Flood Beam, 10-30 Volt, Female Deutsch Connector

LEDs: 6
IP: IP67

Cube Lights

MTLW0303-6S



3" x 3" 6 Diode LED Work Light, 2520 Lumen Spot Beam, 10-30 Volt, Female Deutsch Connector

LEDs: 6
IP: IP67

Magnetic Lights

MTLW3030-MRS-5



4 Diode Rechargeable LED Work Light, Magnetic Base

LEDs: 4

LED WORK LIGHTS



Magnetic Lights

MTLW7050F-MRS-COB



COB LED Work Light, Magnetic Handle, Rechargeable

LEDs: 2
IP: IPx5

Oval Work Lights

MTLW56040-13



4" x 6" Oval 13 Diode LED Work Light, 3510 Lumen Flood Beam, 10-30 Volt, IP67

LEDs: 13
IP: IP67

Rectangular Work Lights

MTLW4030-6



4" x 3" Rectangular LED Work Light, 6 Diodes White, 6 Diodes Amber, 2,200 Lumens, Multi Function, Strobe

LEDs: 6 White / 6 Amber
IP: IP68

Rectangular Work Lights

MTLW5040



8 Diode Rectangular LED Work Light, 840 Lumen Flood Beam, 9-36 Volts

LEDs: 8
IP: IP67

Rectangular Work Lights

MTLW52040-6



2" x 4" Rectangular 6 Diode LED Work Light, 1200 Lumen Flood Beam

LEDs: 6
IP: IP68

Rectangular Work Lights

MTLW54020-33



2" x 4" Rectangular 33 Diode LED Work Light, 726 Lumen Flood Beam, 10-30 Volt, IP67

LEDs: 33
IP: IP67



Rectangular Work Lights

MTLW6008



2" x 6" Rectangular 6 Diode LED Work Light, 1260 Lumen
25 Degree Beam, 10-30 Volt

LEDs: 6
IP: IP67

Rectangular Work Lights

MTLW6008-18



6 1/2" x 2" Rectangular LED Work Light, 9 Diodes / 1,200
Lumens White, 9 Diode / 600 Lumens Amber Strobe

LEDs: 9 White / 9 Amber
IP: IP68

Rectangular Work Lights

MTLW6008-5



2" x 6" Rectangular 6 Diode LED Work Light, 1260
Lumen 25 Degree Beam, 10-30 Volt, Female Deutsch
Connector

LEDs: 6
IP: IP67

Rectangular Work Lights

MTLW6008F



2" x 6" Rectangular 6 Diode Flanged LED Work Light,
1440 Lumen 25 Degree Beam, 10-30 Volt, IP67

LEDs: 6
IP: IP67

Rectangular Work Lights

MTLW6020



2" x 6" Rectangular 20 Diode LED Work Light, 1200
Lumen, 9-32 Volt

LEDs: 20
IP: IP67

Rock Lights

MTLWRL-4RGB



4 Piece LED Rock Light Set, RGB Diode, Bluetooth
Control, 9-32 Volt

LEDs: 3
IP: IP68

LED WORK LIGHTS



Rock Lights

MTLWRL-8RGB



8 Piece LED Rock Light Set, RGB Diode, Bluetooth Control, 9-32 Volt

LEDs: 3
IP: IP68

Round Work Lights

MTLEDAX4411-19C



19 Diode Round LED Work Light, Spot Beam, 12 Volts

LEDs: 19

Round Work Lights

MTLEDAX4411-6C



6 Diode Round LED Work Light, Flood Beam, 10-80 Volts, Reflective Aluminium Base

LEDs: 6
IP: IPx6

Round Work Lights

MTLW50020-1



2" Round 1 Diode LED Work Light, 700 Lumen Flood Beam, 10-30 Volts

LEDs: 1
IP: IP68

Round Work Lights

MTLW50040-9



5" Round 9 Diode LED Work Light, 1800 Lumen Flood Beam

LEDs: 9
IP: IP68

Round Work Lights

MTLW50050-6



5" Round 6 Diode LED Work Light, 1200 Lumen Flood Beam

LEDs: 5
IP: IP68



Round Work Lights

MTLW53500-6



3.5" Round 6 Diode LED Work Light, 1440 Lumen Flood Beam, 10-30 Volts, IP67

LEDs: 5
IP: IP67

Round Work Lights

MTLW6007



6" Round 7 Diode LED Work Light, 7000 Lumen Flood Beam, 10-30 Volt

LEDs: 7
IP: IP67

Safety Lights

MTLW2040-2B



2" x 2" Rectangular 2 Diode Blue LED Safety Light, Spot Beam, 10-110 Volt

LEDs: 2
IP: IP67

Safety Lights

MTLW2040-2R



2" x 2" Rectangular 2 Diode Red LED Safety Light, Spot Beam, 10-110 Volt

LEDs: 2
IP: IP67

Square Work Lights

MTLW53030-5



3" Square 5 Diode LED Work Light, 975 Lumen Flood Beam, 10-30 Volt

LEDs: 5
IP: IP68

Square Work Lights

MTLW54040-6



4" Square 6 Diode LED Work Light, 3660 Lumen Flood Beam, 10-30 Volt, IP67

LEDs: 6
IP: IP67

LED WORK LIGHTS



Square Work Lights

MTLW54040-9



4" Square 9 Diode LED Work Light, 1800 Lumen Flood Beam

LEDs: 9
IP: IP67

Square Work Lights

MTLW55050-9



5" Square 9 Diode LED Work Light, 3450 Lumen Flood Beam, 10-30 Volt, IP67

LEDs: 9
IP: IP67

LED WORK LIGHTS



Double Row

MTLW90803



8" 12 Diode Double Row LED Light Bar, 10V-30V, 3,200 Lumens w/Harness

LEDs: 12
IP: IP67

Double Row

MTLW91053



10.5" 18 Diode Double Row LED Light Bar, 10V-30V, 4,900 Lumens w/Harness

LEDs: 18
IP: IP67

Double Row

MTLW92003



20" 36 Diode Double Row LED Light Bar, 10V-30V, 9,700 Lumens w/Harness

LEDs: 36
IP: IP67

Double Row

MTLW92303



23" 42 Diode Double Row LED Light Bar, 10V-30V, 11,300 Lumens w/Harness

LEDs: 42
IP: IP67

LED LIGHT BARS

Double Row

MTLW93203



32" 60 Diode Double Row LED Light Bar, 10V-30V, 16,200 Lumens w/Harness

LEDs: 60
IP: IP67

Double Row

MTLW94203



42" 78 Diode Double Row LED Light Bar, 10V-30V, 12,060 Lumens w/Harness

LEDs: 78
IP: IP67



Double Row

MTLW95003



50" 96 Diode Double Row LED Light Bar, 10V-30V, 25,920 Lumens w/Harness

LEDs: 96
IP: IP67

Signal Lights

MTLBL2000R



16" Black Steel Frame LED Light Bar, 3 x MTLED2000-4R 4 Diode Round Red Lights

LEDs: 3 x 4
SAE: P2

Signal Lights

MTLBL2500R



16" Black Steel Frame LED Light Bar, 3 x 4 Diode Round Red Lights

LEDs:
IP:
SAE:

Signal Lights

MTLLB1017STT-13R



1" x 16" 5 Wire Auxillary LED Stop / Tail / Turn Light, Red

LEDs: 13
SAE: P2S2

LED LIGHT BARS



Fender Mount Lights

MTFM4102R



Single Face Fender Mount, 2057 Bulb, w/Red Chrome Die Case Base

Bulbs: 1157 Bulb
SAE: STI

Fender Mount Lights

MTFM4202RA



Red & Amber Fender Mount, 1157 Bulb w/Chrome ABS Base

Bulbs: 1157 Bulb
SAE: STIP

Fender Mount Lights

MTFM4302AA



Amber/Amber Fender Mount, 2057 Bulb, Black Die Cast Base

Bulbs: 2057 Bulb
SAE: IP

Fender Mount Lights

MTFM5403RA



Amber/Red Fender Mount w/Side Marker, Black ABS Base

Bulbs: 1157 Bulb
SAE: AP2 / IP

Fender Mount Lights

MTFMR4102A



Amber Replacement Lens For FM4101, FM4102 & FM4302

Kits & Assemblies

MTKT2140R

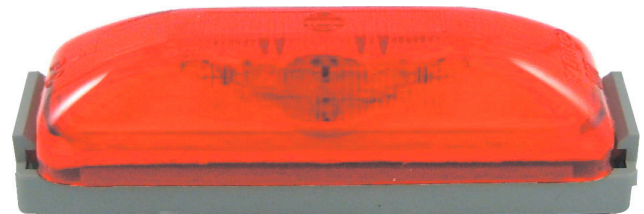

1" x 4" Rectangular Sealed Red Light Kit, Gray Base Mount w/Hotwire

Bulbs: Sealed Housing
SAE: P2PC

INCANDESCENT
LIGHTS



Kits & Assemblies

MTKT3200A



2" Round Sealed Amber Kit w/Open Grommet, Pigtail, & Branch Deflector

Bulbs: Sealed Housing

SAE: P2

Kits & Assemblies

MTKT3200R



2" Round Sealed Red Kit w/Open Grommet, Pigtail, & Branch Deflector

Bulbs: Sealed Housing

SAE: P2

Kits & Assemblies

MTKT3205A



2" Round Sealed Amber Kit w/Open Grommet & Pigtail

Bulbs: Sealed Housing

SAE: P2

Kits & Assemblies

MTKT3205R



2" Round Red Marker Light Kit w/Open Grommet & Pigtail

Bulbs: Sealed Housing

SAE: P2

Kits & Assemblies

MTKT3255A



2.5" Round Sealed Amber Kit w/Open Grommet & Pigtail

Bulbs: Sealed Housing

SAE: P2

Kits & Assemblies

MTKT3255R



2.5" Round Sealed Red Kit w/Open Grommet & Pigtail

Bulbs: Sealed Housing

SAE: P2

INCANDESCENT LIGHTS



Kits & Assemblies

MTKT3260A

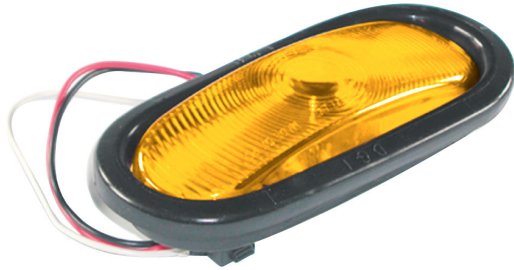

Oval Amber Sealed Light Kit w/Open Grommet & Pigtail

Bulbs: Sealed Housing
SAE: IP

Kits & Assemblies

MTKT3260C



Oval Clear Sealed Utility/Dome Light Kit w/Open Grommet & Pigtail

Bulbs: Sealed Housing

Kits & Assemblies

MTKT3260R



Oval Red Sealed Light Kit w/Open Grommet & Pigtail

Bulbs: Sealed Housing
SAE: STIP

Kits & Assemblies

MTKT3260W



Oval White Sealed Light Kit w/Open Grommet & Pigtail

Bulbs: Sealed Housing
SAE: R

Kits & Assemblies

MTKT3405A



4" Round Amber Sealed Light Kit w/Open Grommet & Pigtail

Bulbs: Sealed Housing
SAE: IP

Kits & Assemblies

MTKT3405C



4" Round Clear Sealed Utility/Dome Light Kit w/Open Grommet & Pigtail

Bulbs: Sealed Housing

INCANDESCENT
LIGHTS



Kits & Assemblies

MTKT3405R



4" Round Red Sealed Light Kit w/Open Grommet & Pigtail

Bulbs: Sealed Housing
SAE: STIP

Kits & Assemblies

MTKT3405W



4" Round White Sealed Light Kit w/Open Grommet & Pigtail

Bulbs: Sealed Housing
SAE: R

Kits & Assemblies

MTTL4400K-1



Complete Trailer Light Kit For Vehicles Under 80" Wide, Includes MTTL440, MTTL4400L, 2 Amber Side Markers, License Bracket, 25 ft Wire Harness w/ Trunk Connector, & Mounting Hardware

License Lights

MTP1002



ABS Gray License Light, No Seal, Replaces 26335

Bulbs: 67 Bulb
SAE: L

License Lights

MTP1003

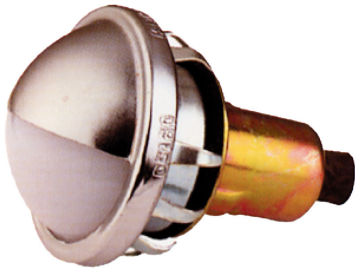

Chrome On Brass Snap-In License Light

Bulbs: 67 Bulb
SAE: L

License Lights

MTP2000



Gray License Light Housing 15729

INCANDESCENT LIGHTS



License Lights

MTLP2001



ABS Gray License Light Assembly, w/SE1225L Light

Bulbs: Sealed Housing

SAE: L

License Lights

MTLP2002



ABS Gray License Light Assembly w/Pigtail

Bulbs: Sealed Housing

SAE: L

License Lights

MTLP3000



Chrome Plated Steel License Light Housing

Bulbs: 67 Bulb

SAE: L

Lights Bars

MTLB2000R



Light Bar 3 x MTSE2000R 2" Round Red Lights On 16" Black Steel Frame

Bulbs: Sealed Housing

SAE: P3

Lights Bars

MTLB2500R



Light Bar 3 x MTSE2500R 2.5" Round Red Lights On 16" Black Steel Frame

Bulbs: Sealed Housing

SAE: P3

Oval Stop/Turn/Tail/Back-Up Lights

MTSE2238A



Sealed Amber Dual Function Light

Bulbs: Sealed Housing

SAE: IP

INCANDESCENT LIGHTS



Oval Stop/Turn/Tail/Back-Up Lights

MTSE2238R



Sealed Oval Red Stop / Tail / Turn Light

Bulbs: Sealed Housing
SAE: STIP

Oval Stop/Turn/Tail/Back-Up Lights

MTSE2238W



Sealed Oval White Back Up Light

Bulbs: Sealed Housing
SAE: IP

Oval Stop/Turn/Tail/Back-Up Lights

MTSR2238A



Sealed Oval Amber Mid Turn Signal Light w/Reflective Lens

Bulbs: Sealed Housing
SAE: AEP2

Rectangular Clearance Marker Lights

MTML1020R



1" X 2.75" Rectangular Red Marker Light, 1 Bulb

Bulbs: 194 Bulb
SAE: P2

Rectangular Clearance Marker Lights

MTML2040A



2" x 4" Rectangular Double Bulb Amber Marker Light

Bulbs: 194 Bulb
SAE: P2

Rectangular Clearance Marker Lights

MTML2040R

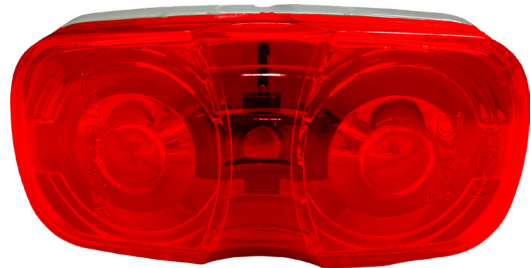

2" x 4" Rectangular Double Bulb Red Marker Light

Bulbs: 194 Bulb
SAE: P2

INCANDESCENT LIGHTS



Rectangular Clearance Marker Lights

MTML2042A

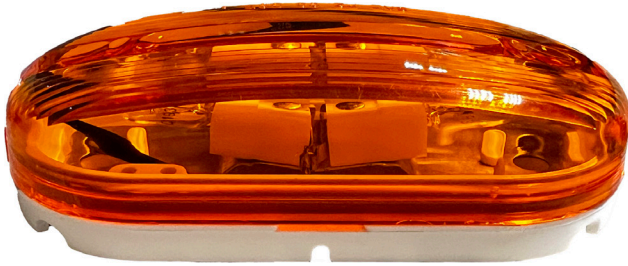

2" x 4" Amber Oval Marker Light

Bulbs: 194 Bulb
SAE: A P2

Rectangular Clearance Marker Lights

MTML2042R

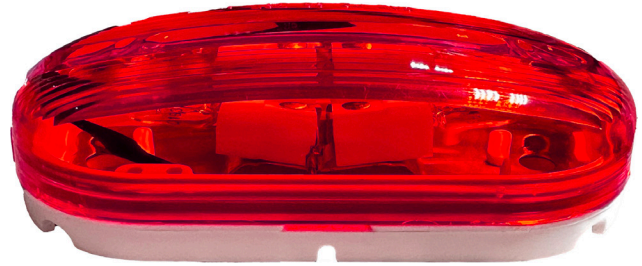

2" x 4" Red Oval Marker Light

Bulbs: 194 Bulb
SAE: A P2

Rectangular Clearance Marker Lights

MTML2043A



2" X 4" Oval 2 Bulb Amber Marker Light

Bulbs: 1893 Bulb
SAE: P2

Rectangular Clearance Marker Lights

MTML2043R

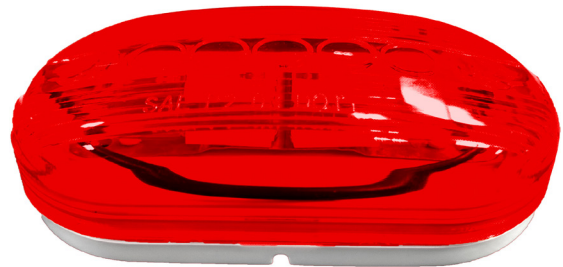

2" X 4" Oval 2 Bulb Red Marker Light

Bulbs: 1893 Bulb
SAE: P2PC

Rectangular Clearance Marker Lights

MTML2045A



2" x 4" Rectangular Amber Double Bulb Marker Light w/
Chrome ABS Body

Bulbs: 194 Bulb
SAE: P2

Rectangular Clearance Marker Lights

MTML2045R

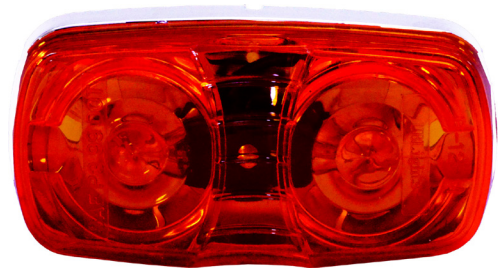

2" x 4" Rectangular Red Double Bulb Marker Light w/
Chrome ABS Body

Bulbs: 194 Bulb
SAE: P2

INCANDESCENT
LIGHTS



Rectangular Clearance Marker Lights

MTML2540R



2" x 4" Rectangular Red Single Bulb Marker Light w/
Chrome ABS Bezel

Bulbs: 194 Bulb
SAE: P2

Rectangular Clearance Marker Lights

MTMLR2043R



Red Replacement Lens For ML2043R

Rectangular Clearance Marker Lights

MTSE1040A

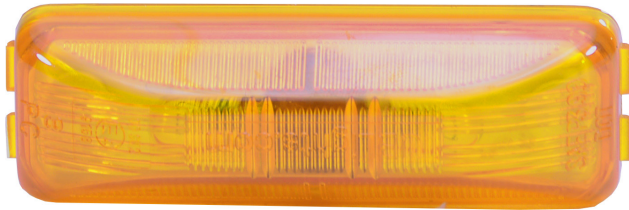

1" x 4" Rectangular Amber Sealed Marker Light

Bulbs: Sealed Housing
SAE: P2PC

Rectangular Clearance Marker Lights

MTSE1040ABS



1" x 4" Rectangular Sealed ABS Brake System
Indicator Light

Bulbs: Sealed Housing

Rectangular Clearance Marker Lights

MTSE1040C

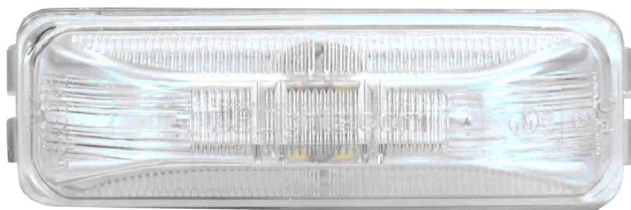

1" x 4" Rectangular Clear Sealed Utility / Dome Light

Bulbs: Sealed Housing

Rectangular Clearance Marker Lights

MTSE1040R

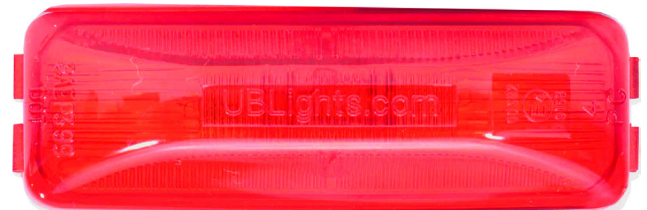

1" x 4" Rectangular Red Sealed Marker Light

Bulbs: Sealed Housing
SAE: P2PC

INCANDESCENT LIGHTS



Rectangular Clearance Marker Lights

MTSE1225A



1" x 2" Rectangular Amber Sealed Marker Light

Bulbs: Sealed Housing

SAE: P3

Rectangular Clearance Marker Lights

MTSE1225C



1" x 2" Rectangular Clear Sealed Utility / Dome Light

Bulbs: Sealed Housing

Rectangular Clearance Marker Lights

MTSE1225L



1" x 2" Rectangular Clear Sealed License Light

Bulbs: Sealed Housing

SAE: L

Rectangular Clearance Marker Lights

MTSE1225R



1" x 2" Rectangular Red Sealed Marker Light

Bulbs: Sealed Housing

SAE: P3

Rectangular Clearance Marker Lights, Reflex

MTMR2241A



2" x 4" Amber Low Profile Reflective Oval Marker Light,
2 Bulbs

Bulbs: 194 Bulb

SAE: AP2

Rectangular Clearance Marker Lights, Reflex

MTMRR2041A

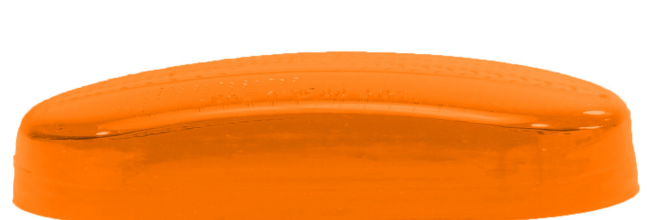

Replacement Amber Reflective Lens For MR2041A And
MR2241A

INCANDESCENT
LIGHTS



Rectangular Clearance Marker Lights, Reflex

MTSR2238R



Reflective Red Mid-Turn Marker Light

Bulbs: Sealed Housing
SAE: AEP2

Rectangular Stop/Turn/Tail/Back-Up Lights

MTSE4060RW

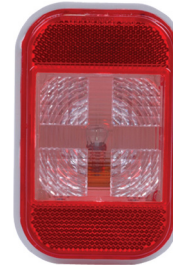

4" x 6" Rectangular Sealed Back-Up Light w/Built-In Reflector

Bulbs: Sealed Housing
SAE: AR

Round Clearance Marker Lights

MTSE2000A



2" Round Amber Sealed Marker Light

Bulbs: Sealed Housing
SAE: P2

Round Clearance Marker Lights

MTSE2000ABS



2" Round Amber Sealed ABS Brake System Indicator Light

Bulbs: Sealed Housing

Round Clearance Marker Lights

MTSE2000R



2" Round Red Sealed Marker Light

Bulbs: Sealed Housing
SAE: P2

Round Clearance Marker Lights

MTSE2500A



2.5" Round Amber Sealed Marker Light

Bulbs: Sealed Housing
SAE: P2

INCANDESCENT LIGHTS



Round Clearance Marker Lights

MTSE2500ABS



2.5" Round Amber Sealed ABS Brake System Indicator Light

Bulbs: Sealed Housing

Round Clearance Marker Lights

MTSE2500R



2.5" Round Red Sealed Marker Light

Bulbs: Sealed Housing

SAE: P2

Round Clearance Marker Lights

MTSEF2500R-2

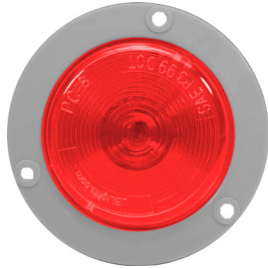

2.5" Round Red Sealed Flush Mount w/Gray Flange

Bulbs: Sealed Housing

SAE: P2

Round Clearance Marker Lights, Reflex

MTSR2500A



2.5" Round Reflective Amber Sealed Marker Light

Bulbs: Sealed Housing

SAE: AEP2

Round Clearance Marker Lights, Reflex

MTSR2500R



2.5" Round Reflective Red Sealed Marker Light

Bulbs: Sealed Housing

SAE: AEP2

Round Clearance Marker Lights, Reflex

MTSRF2000A

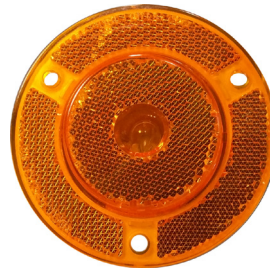

2" Amber Sealed Marker Light w/Reflective Flange

Bulbs: Sealed Housing

SAE: AP2

INCANDESCENT LIGHTS



Round Clearance Marker Lights, Reflex

MTSRF2000R



2" Red Sealed Marker Light w/Reflective Flange

Bulbs: Sealed Housing
SAE: AP2

Round Clearance Marker Lights, Reflex

MTSRF2500A-2



2.5" Round Amber Sealed Flush Mount, Reflective Lens, w/Gray Flange

Bulbs: Sealed Housing
SAE: P2

Round Clearance Marker Lights, Reflex

MTSRF2500R-2



2.5" Round Red Sealed Flush Mount, Reflective Lens, w/ Gray Flange

Bulbs: Sealed Housing
SAE: P2

Round Stop/Tail/Turn/Back Up Lights

MTSEF4000W-2

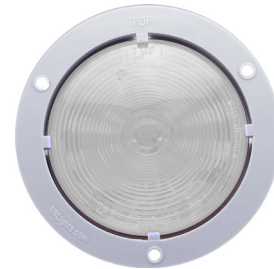

4" Round Sealed White Back-Up Light w/Gray Flange, Incandescent

Bulbs: Sealed Housing
SAE: R

Round Stop/Turn/Tail/Back-Up Lights

MTSE4000A



Sealed 4" Round Amber Dual Function Light

Bulbs: Sealed Housing
SAE: IP

Round Stop/Turn/Tail/Back-Up Lights

MTSE4000R



4" Sealed Round Red Stop / Tail / Turn Light

Bulbs: Sealed Housing
SAE: STIP

INCANDESCENT LIGHTS



Round Stop/Turn/Tail/Back-Up Lights

MTSE4000W



4" Sealed Round White Back Up

Bulbs: Sealed Housing
SAE: IP

Round Stop/Turn/Tail/Back-Up Lights

MTSEF4000R-2B



4" Round Sealed Red Stop / Tail / Turn Light, Flush Mount w/Grey Flange, Bulk Pack

Bulbs: Sealed Housing
SAE: STIP

Round Stop/Turn/Tail/Back-Up Lights

MTSEF4000R-2S



4" Round Sealed Red Stop / Tail / Turn Light, Flush Mount w/Grey Flange

Bulbs: Sealed Housing
SAE: STIP

Round Stop/Turn/Tail/Back-Up Lights

MTSR4000R



4" Round Sealed Red Stop / Tail / Turn w/Reflective Lens

Bulbs: Sealed Housing
SAE: SITA

Trailer Modules

MTTM8000U

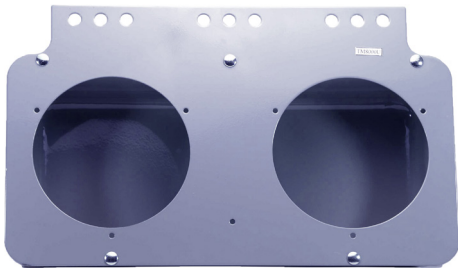

2-Hole Universal Trailer Module, Module Only

Trailer Modules

MTTM8050L



2-Hole Complete Road-Side Trailer Module w/Red STT Lamps (MTSE4000R), Red Side Marker Lamps (MTSE1040R), Reflector (MTRF2012R) & Wire Harness (MTPT9050)

SAE: STIP / P2PC / A

INCANDESCENT LIGHTS



Trailer Modules

MTTM8050R



2-Hole Complete Road-Side Trailer Module w/Red STT Lamps (MTSE4000R), Red Side Marker Lamps (MTSE1040R), Reflector (MTRF2012R) & Wire Harness (MTPT9050)

SAE: STIP / P2PC / A

Trailer Modules

MTTM8050U



2-Hole Universal Trailer Module, Complete w/Red STT Lamps (MTSE4000R), Reflector (MTRF2012R), & Wire Harness (MTPT9000)

SAE: STIP / A

Trailer Utility Lights

MTTL4300R



4" Round Black Enamel Steel Red Stop / Tail / Turn Pot Light

Bulbs: 1157 Bulb

SAE: STI

Trailer Utility Lights

MTTL4305R



4" Round Stainless Steel Red Stop / Tail / Turn Pot Light

Bulbs: 1157 Bulb

SAE: STI

Trailer Utility Lights

MTTL4400



Red Stop / Tail / Turn Curb-Side Tail Light Combination For Vehicles Under 80" Wide

Bulbs: 1157 & 194

SAE: AIST / AP2

Trailer Utility Lights

MTTL4400L

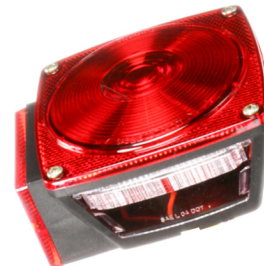

Red Stop / Tail / Turn Road-Side Tail Light Combination For Vehicles Under 80" Wide

Bulbs: 1157 & 194

SAE: AIST / AP2 / L

INCANDESCENT LIGHTS



Trailer Utility Lights

MTTL4402



4" Round Stud Mount Curb-Side Red Stop / Tail / Turn,
Plastic Housing

Bulbs: 1157 Bulb
SAE: STIP

Trailer Utility Lights

MTTL4402L



4" Round Stud Mount Road-Side Red Stop / Tail / Turn,
Plastic Housing

Bulbs: 1157 Bulb
SAE: STIPL

Trailer Utility Lights

MTTL5441



Submersible Red Road-Side Combination Stop / Tail /
Turn For Vehicle Under 80" Wide

Bulbs: 1157 & 194
SAE: AIST / AP2

Trailer Utility Lights

MTTL5441L



Submersible Red Curb-Side Combination Stop / Tail /
Turn For Vehicle Under 80" Wide

Bulbs: 1157 & 194
SAE: AIST / AP2 / L

Trailer Utility Lights

MTTL6400



Universal Combination Red Stop / Tail / Turn / Backup
Light w/ Reflective Lens

Bulbs: 1156 & 1157
SAE: AIRST

Trailer Utility Lights

MTTLR6400R

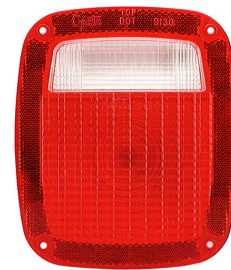

Red Replacement Lens For TL6400

INCANDESCENT
LIGHTS



Utility / Dome

MTSE2238C



Sealed Clear Oval Utility / Dome Light

Bulbs: Sealed Housing

Utility / Dome

MTSE4000C



4" Clear Round Interior Dome Light

Bulbs: Sealed Housing



Halogen

MTAG4040



4" x 4.5" Square Halogen Work Light, ABS Body, H3

Bulbs: H3 (HB5503-12)

Halogen

MTAG4045



4" x 4.5" Square Halogen Work Light, H3

Bulbs: H3 (HB5503-12)

Rubber

MTAX4411



5" Round Par 36 Work Light, Trapezoid Beam Pattern

Bulbs: MTSB4411

Sealed Beam

MTSB4411



Sealed Beam Par 36 Replacement Light for 4411 Series

Sealed Beam

MTSB4419



Sealed Beam Par 46 Replacement Light for 4419 Series

Steel Housing

MTAXB4411



5" Round Steel Par 36 Work Light, Rear Stud Mount

Bulbs: MTSB4411

INCANDESCENT
WORK LIGHTS





Base Mounts

MTBM1020RB



Black Rail Mount For 1" x 2" Lights

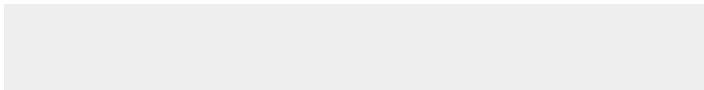

Base Mounts

MTBM1040B



Gray Base Mount w/Hotwire & Built-In Ground, For 1" x 4" Lights

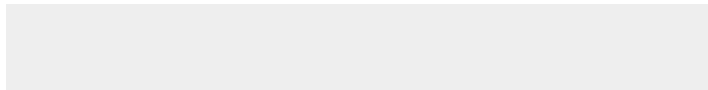

Base Mounts

MTBM1040BB

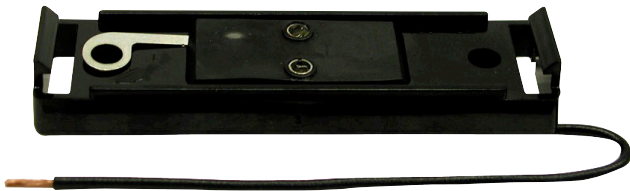

Black Base Mount w/Hotwire & Built-In Ground For 1" x 4" Lights

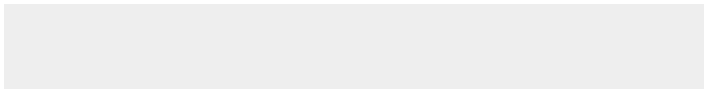

Base Mounts

MTBM1040BC



Chrome Base Mount w/Hotwire & Built-In Ground For 1" x 4" Lights

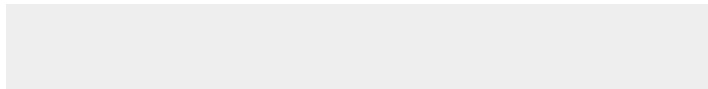

Base Mounts

MTBM2500G



Gray Surface Mount For 2" & 2.5" Round Lights

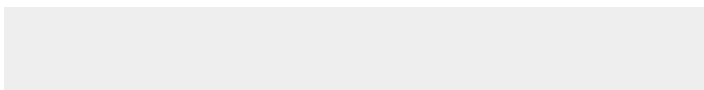

Branch Deflectors

MTBD2000



Gray 2" Branch Deflector For Round Lights

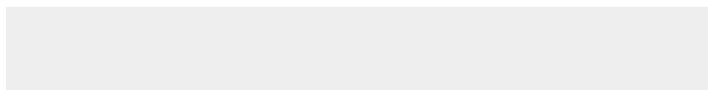



Electrical Accessories

MTJB0700



7-Terminal Junction Box, #10 Studs, Unit is di-electric tested to 4000 volts without leakage.

Flanges

MTFL2001



Round Black ABS Flange, For 2" Round Lights

Flanges

MTFL2002

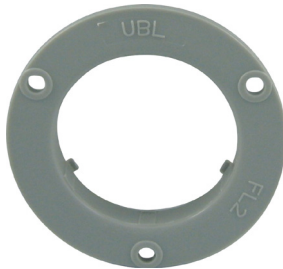

Round Gray ABS Flange, For 2" Round Lights

Flanges

MTFL2005



Round Chrome ABS Flange, For 2" Round Lights

Flanges

MTFL2238-1



Oval Black ABS Flange, For 2" x 6" Oval Lights

Flanges

MTFL2238-2



Oval Gray ABS Flange, For 2" x 6" Oval Lights



Flanges

MTFL2238SS



Stainless Steel Oval Mounting Bracket w/Flange

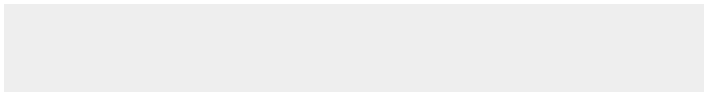

Flanges

MTFL2502



Round Gray ABS Flange, For 2.5" Round Lights

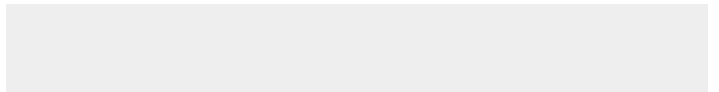

Flanges

MTFL2505



Round Chrome ABS Flange, For 2.5" Round Lights

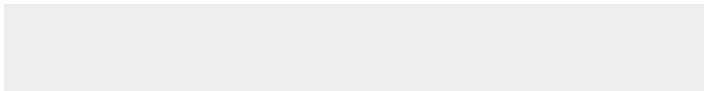

Flanges

MTFL4000SS



Round Stainless Steel Flange, For 4" Round Lights

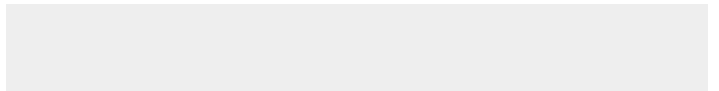

Flanges

MTFL4002

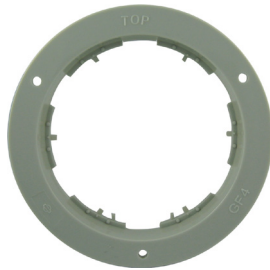

Round Gray ABS Flange, For 4" Round Lights

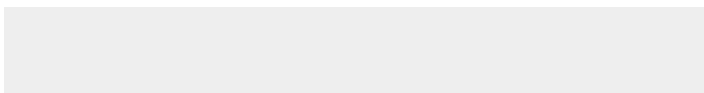

Flanges

MTFL4005



Chrome ABS Flange, For 4" Round Lights

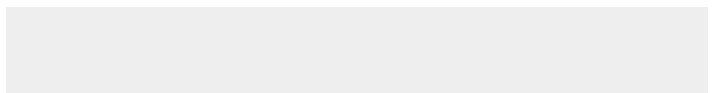



Flanges

MTFL4060SS



Rectangular Stainless Steel Flange, For 4" x 6" Lights

Grommets

MTGR2000



Open Back Grommet For 2" Round Lights

Grommets

MTGR2001



Closed Back Round Grommet For 2" Round Lights

Grommets

MTGR2238

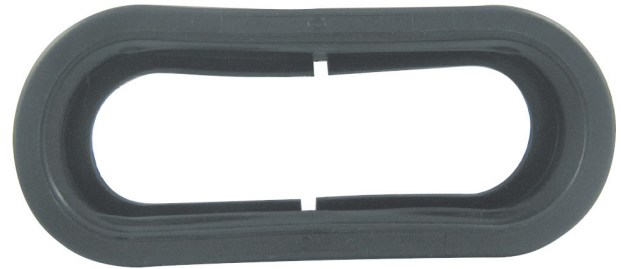

Open Back Grommet For 2" X 6" Oval Lights

Grommets

MTGR2239



Closed Back Oval Grommet For 2" X 6" Oval Lights

Grommets

MTGR2500



Open Back Grommet For 2.5" Round Lights



Grommets

MTGR2501



Closed Back Grommet For 2.5" Round Lights

Grommets

MTGR2502



Recessed Grommet For 2.5" Round Lights

Grommets

MTGR4000



Open Back Grommet For 4" Round Lights

Grommets

MTGR4060



Rectangular Open Back Grommet For 4" x 6" Lights

Mounting Brackets

MTLH2000P

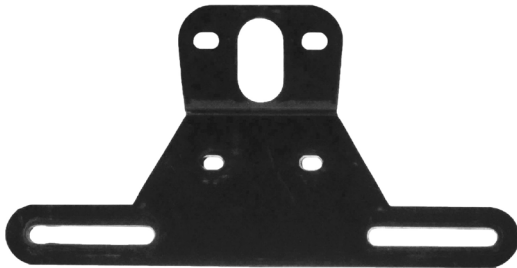

Heavy Duty ABS License Holder 9.5" X 4.8"

Mounting Brackets

MTMB2238



Black Enamel Steel Right Angle Mounting Bracket For 2" X 6" Oval Lights



Mounting Brackets

MTMB4000

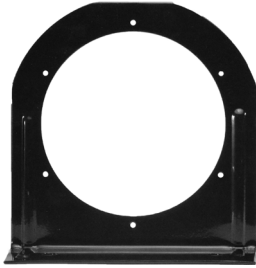

Black Enamel Steel Right Angle Mounting Bracket For 4" Round Lights

Pigtails

MTPT1002



9" Lead Wire Harness w/Single Contact Plug & Sealed Connector

Length: 12" LEAD

Pigtails

MTPT6020

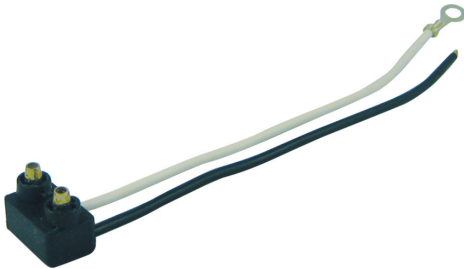

6" Lead Pigtail w/Right Angle Plug & Single Contact

Length: 6"

Pigtails

MTPT6020-100



100' Continuous MTPT6020 Pigtail Roll, 9" Centers

Pigtails

MTPT6020-3



Single Contact String Plug Pigtail Set w/3 Connectors, 10" Centers

Pigtails

MTPT6020C



Single Contact Pigtail w/Right Angle Plug & 6" Lead (Copper)

Length: 6"



Pigtails

MTPT6022



Single Contact Right Angle Plug w/6" Lead & Bullet Connectors

Length: 6"

Pigtails

MTPT6023



Single Contact Pigtail, Female Plug w/Bullet Ground Connectors

Length: 5" & 6"

Pigtails

MTPT6182



Straight Weather Proof Pigtail w/2 Pin AMP Style Connector

Pigtails

MTPT6183



Straight Weather Proof Pigtail w/2 Pin AMP Style & Bullet Connector

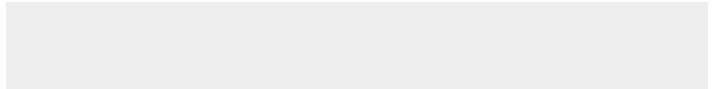
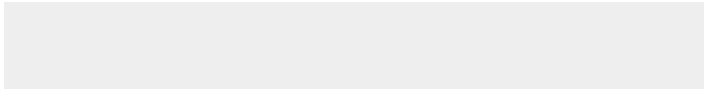

Pigtails

MTPT6800-5



10" Pigtail w/Deutsch Connector

Length: 10

Pigtails

MTPT9120

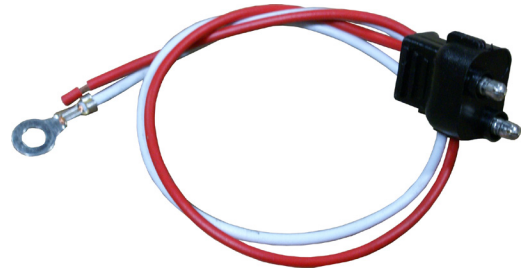

Single Function Pigtail, Straight Plug, 12" Lead

Length: 12"



Pigtails

MTPT9180



Straight Pigtail w/Angle Plug, Double Contact, & 9.5" Lead

Length: 9"

Pigtails

MTPT9181



Pigtail w/Straight Plug, Double Contact w/Weather Proof AMP Connector

Length: 6"

Pigtails

MTPT9182

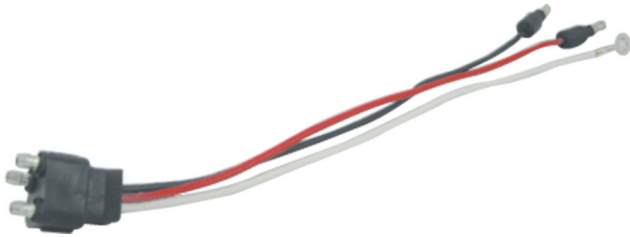

Pigtail w/Straight Plug, Double Contact w/9.5" Lead And Bullet Connectors

Length: 9.5"

Pigtails

MTPT9183

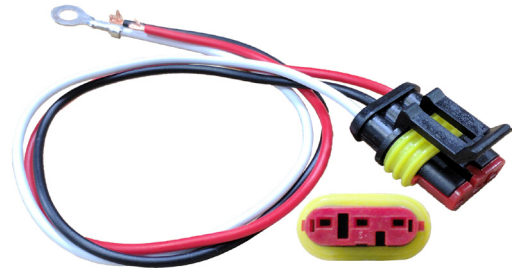

Straight Weather Proof AMP Connector Pigtail w/Blunt Wires

Pigtails

MTPT9183-BLT

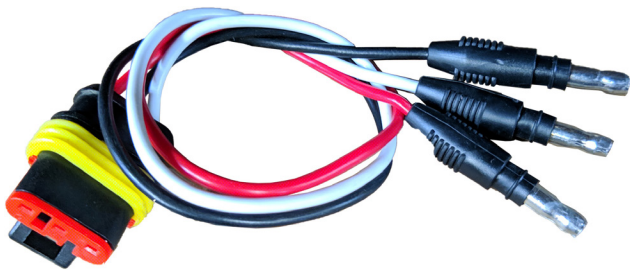

Straight Weather Proof Pigtail w/AMP Style Connector, 3 Pin, .180 Bullet Connector

Pigtails

MTPT9520

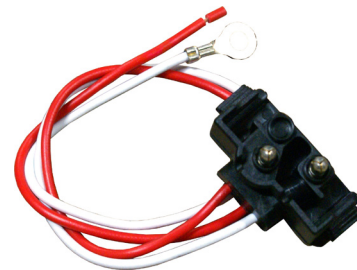

Pigtail For Use w/MTLED2238CB, Right Angle Plug, Single Function, 12" Lead

Length: 12"



Pigtails

MTP19530



Pigtail w/Right Angle Plug, Double Contact w/9.5" Lead

Length: 9"

Pigtails

MTP19532

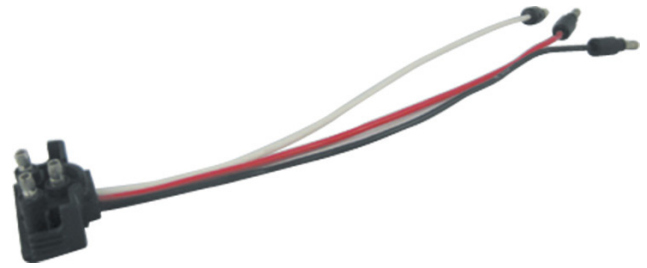

Pigtail w/Right Angle Plug, Double Contact w/9.5" Lead & Bullet Connectors

Length: 9.5"

Reflectors

MTRF1421A



Rectangular 1.125" x 4.375" Adhesive Amber Reflector w/2 Mounting Holes

SAE: A

Reflectors

MTRF2001A

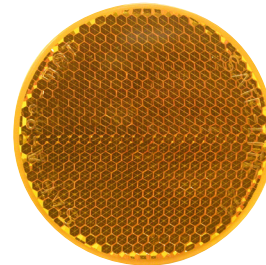

Round 2.1875" Amber Adhesive Backed Reflector

SAE: A

Reflectors

MTRF2001R

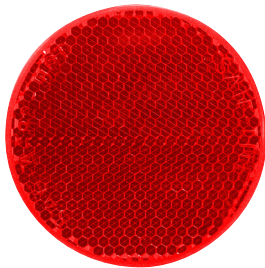

Round 2.1875" Red Adhesive Backed Reflector

SAE: A

Reflectors

MTRF2012A

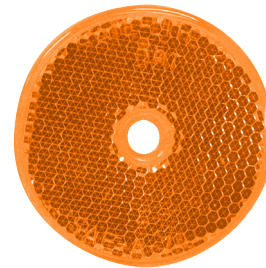

Round 2.1875" Amber Reflector w/Plastic Back & Center Hole

SAE: A



Reflectors

MTRF2012R

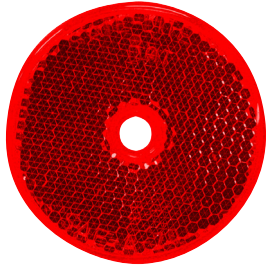

Round 2.1875" Red Reflector w/Plastic Back & Center Hole

SAE: A

Reflectors

MTRF3001A



Round 3.1875" Amber Adhesive Backed Reflector

SAE: A

Reflectors

MTRF3001R



Round 3.1875" Red Adhesive Backed Reflector

SAE: A

Reflectors

MTRF3012A

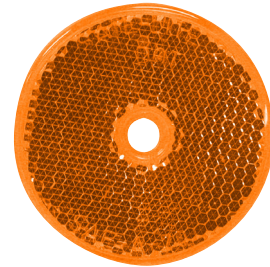

Round 3.1875" Amber Reflector w/Plastic Back & Center Hole

SAE: A

Reflectors

MTRF3012R

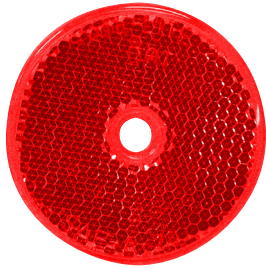

Round 3.1875" Red Reflector w/Plastic Back & Center Hole

SAE: A

Reflectors

MTRF3023A



Round 3" Aluminum Backed Amber Reflector w/2 Mounting Holes

SAE: A



Reflectors

MTRF3023R



Round 3" Aluminum Backed Red Reflector w/2 Mounting Holes

Wire Harnesses

MTPT2504



4 Wire Trailer Harness, 25' w/Plugs

SAE: A

Length: 25'

Wire Harnesses

MTPT6800-DT1



LED Light Bar Wire Harness, 1 Deutsch Connector, Fuse, Relay, Rocker Switch, 18 Ft

Wire Harnesses

MTPT6800-DT2



LED Light Bar Wire Harness, 2 Deutsch Connector, Fuse, Relay, Rocker Switch, 18 Ft

IP: IP65 (Plug)

IP: IP65 (Plug)

Wire Harnesses

MPTOE002



Rear Trailer Harness w/3 x LED0700R

Wire Harnesses

MTW717000-1



7 Wire Trailer Cable, 14 Gauge, 100' Roll

LEDs: 3





Convex

MTCX500SS



5" Round Stainless Steel Convex Mirror

Convex

MTCX600SS



6" Round Stainless Steel Convex Mirror

Convex

MTCX750SS



7.5" Round Stainless Steel Convex Mirror

Convex

MTCX755SS



7.5" Round Stainless Steel Offset Convex Mirror

Convex

MTCX850SS



8.5" Round Stainless Steel Convex Mirror

Convex

MTCX855SS



8.5" Round Stainless Steel Offset Convex Mirror

MIRRORS



Convex

MTHW1001

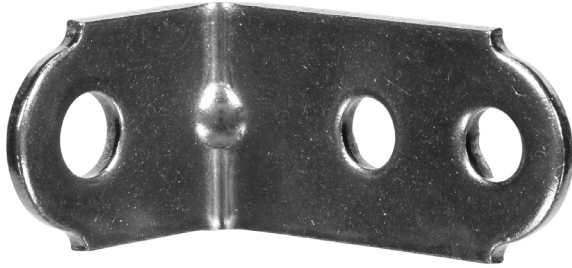

Stainless Steel L Bracket For Convex Mirrors

Convex

MTHW1002



Stainless Steel Arm & Bracket For Convex Mirrors

West Coast Mirrors

MTWC3650



Stainless Steel Tripod Mirror Fender Assembly

West Coast Mirrors

MTWC6160AL



6" x 16" Aluminium West Coast Mirror

West Coast Mirrors

MTWC6165SS



6" x 16" Stainless Steel West Coast Mirror w/Heater

West Coast Mirrors

MTWC7160SS



7" x 16" Stainless Steel West Coast Mirror



West Coast Mirrors

MTWC7165SS



7" x 16" Stainless Steel West Coast Mirror w/Heater



Ingress Protection (IP) Codes

The IP code or ingress protection code indicates how well a device is protected against water and dust. It is defined by the International Electrotechnical Commission (IEC) under the international standard IEC 60529 which classifies and provides a guideline to the degree of protection provided by mechanical casings and electrical enclosures against intrusion, dust, accidental contact, and water. It is published in the European Union by the European Committee for Electrotechnical Standardization (CENELEC) as EN 60529.

The standard aims to provide users more detailed information than vague marketing terms such as waterproof. For example, a work light rated at IP67 is "dust resistant" and can be "immersed in 1 meter of freshwater for up to 30 minutes".

The digits indicate conformity with the conditions summarized in the tables below. The digit 0 is used where no protection is provided. The digit is replaced with the letter X when insufficient data has been gathered to assign a protection level. The device can become less capable, however it cannot become unsafe.

There are no hyphens in a standard IP code. IPX-8, for example, is an invalid IP code.



Ingress Protection (IP) Codes



| IP | 6 | 5 |
|----|--------------------------------------------------------------------------------------------------------------------------------------------------|-----------------------------------------------------------------------------------------------------------------------------------------------------------------------------------------------------------------------------------------------------------------------------------------------|
| | Dust-tight | Water jets |
| | No ingress of dust; complete protection against contact (dust-tight). A vacuum must be applied. Test duration of up to 8 hours based on airflow. | Water projected by a nozzle (6.3 mm (0.25 in)) against enclosure from any direction shall have no harmful effects. Test duration: 1 minute per square meter for at least 3 minutes. Water volume: 12.5 litres per minute Pressure: 30 kPa (4.4 psi) at distance of 3 meters (9.8 ft) (9.8 ft) |



| IP | 6 | 6 |
|----|--------------------------------------------------------------------------------------------------------------------------------------------------|---------------------------------------------------------------------------------------------------------------------------------------------------------------------------------------------------------------------------------------------------------------------------------------------------------------|
| | Dust-tight | Powerful water jets |
| | No ingress of dust; complete protection against contact (dust-tight). A vacuum must be applied. Test duration of up to 8 hours based on airflow. | Water projected in powerful jets (12.5 mm (0.49 in)) against the enclosure from any direction shall have no harmful effects. Test duration: 1 minute per square meter for at least 3 minutes. Water volume: 100 liters per minute (0.37 impgal/s) Pressure: 100 kPa (15 psi) at distance of 3 meters (9.8 ft) |



| IP | 6 | 7 |
|----|--------------------------------------------------------------------------------------------------------------------------------------------------|----------------------------------------------------------------------------------------------------------------------------------------------------------------------------------------------------------------------------------------------------------------------------------------------------------------------------------------------------------------------------------------------------|
| | Dust-tight | Immersion, up to 1 meter (3 ft 3 in) depth |
| | No ingress of dust; complete protection against contact (dust-tight). A vacuum must be applied. Test duration of up to 8 hours based on airflow. | Ingress of water in harmful quantity shall not be possible when the enclosure is immersed in water under defined conditions of pressure and time (up to 1 meter (3 ft 3 in) of submersion). Test duration: 30 minutes. Tested with the lowest point of the enclosure 1,000 mm (39 in) below the surface of the water, or the highest point 150 mm (5.9 in) below the surface, whichever is deeper. |



| IP | 6 | 8 |
|----|--------------------------------------------------------------------------------------------------------------------------------------------------|-----------------------------------------------------------------------------------------------------------------------------------------------------------------------------------------------------------------------------------------------------------------------------------------|
| | Dust-tight | Immersion, 1 meter (3 ft 3 in) or more depth |
| | No ingress of dust; complete protection against contact (dust-tight). A vacuum must be applied. Test duration of up to 8 hours based on airflow. | The equipment is suitable for continuous immersion in water under conditions which shall be specified by the manufacturer. The test depth and duration is expected to be greater than the requirements for IPx7. Depth specified by the manufacturer, generally up to 3 meters (9.8 ft) |



| IP | 6 | 9K |
|----|--------------------------------------------------------------------------------------------------------------------------------------------------|-------------------------------------------------------------------------------------------------------------------------------------------------------------------------------------------------------------------------------------------------------------------------------------------------------------------|
| | Dust-tight | Powerful high-temperature water jets |
| | No ingress of dust; complete protection against contact (dust-tight). A vacuum must be applied. Test duration of up to 8 hours based on airflow. | Protected against close-range high pressure, high-temperature spray downs. Test duration: 1 min/m ² , 3 min. minimum. Water volume: 14–16 liters per minute (0.051–0.059 impgal/s) Pressure: 8–10 MPa (80–100 bar) at distance of 0.10–0.15 meters (3.9 in – 5.9 in) Water temperature: 80 °C (176 °F) |



SAE Lighting Identification Codes

SAE International stands for the International Society of Automotive and Aerospace Engineers. They provide the standards that all vehicle safety products must adhere to. The visible identifiers from SAE identify type of equipment by a letter/number code for each product group.

The lighting identification code is a series of standardized markings for lighting devices which a manufacturer or a supplier may use to mark his product to indicate the SAE Lighting Specification or Specifications to which the device is designed. The code is not intended to limit the manufacturer or supplier in applying other markings to the devices.

The identification code should consist of a series of letters and numbers in the following sequence:

1. SAE.
2. A number within a circle or parentheses indicating the number of compartments in a multicompartment device or the number of separate lamps when more than one compartment or one lamp is needed to satisfy the requirements of the applicable SAE Specification. No number is required for a single compartment device.
3. One or more letters identifying the function or functions for which the device was designed. Multipurpose devices shall be marked to cover each function for which the device was originally designed. Such devices may be used to carry out one or more of these functions. See the identifying designations for SAE Specifications on the next page.
4. The last two numbers of a year which means that the code letters refer to SAE Specifications listed in the SAE Handbook current in the year indicated, or the applicable requirements of Federal Motor Vehicle Safety Standard 108 specified for the device function in the year indicated. To denote that a function meets the requirements of FMVSS 108, but not the current SAE Specification, a dash line shall be placed under the function letter. Example: AIRST 75.

SAE does not approve products; hence; the use of markings in accordance with this code should not be interpreted to mean that a device so marked has SAE approval.



So, as shown on UBLights' MTLED2500-13A marker light, this item is coded as a "Clearance, sidemarker, and identification lamp" approved in 2003. The DOT at the end stands for the approving agency (U.S. Department of Transportation).



SAE Lighting Identification Codes

| | |
|--------------|-------------------------------------------------------------------------------------------------------------------------------------------------------------------|
| A | Reflex reflectors |
| A2 | Wide angle reflex reflectors |
| C | Motorcycle auxiliary front lamps |
| D | Motorcycle and motor-driven cycle turn signal lamps |
| E | Side turn signal lamps—vehicles 12m or more in length |
| E2 | Side turn signal lamps—vehicles less than 12m in length |
| F | Front fog lamps |
| F2 | Fog tail lamps |
| G | Truck cargo lamp |
| H | Sealed beam headlamp |
| HG | Discharge forward lighting (headlamp) |
| HH | Sealed beam headlamp housing |
| HR | Replaceable bulb headlamp |
| I | Turn signal lamps |
| 13 | Turn signal lamps spaced from 75 mm to less than 100 mm from headlamp |
| 14 | Turn signal lamps spaced from 60 mm to less than 75 mm from headlamp |
| 15 | Turn signal lamps spaced less than 60 mm from headlamp |
| 16 | Rear mounted turn signal lamps and front mounted turn signal lamps mounted 100 mm or more from the headlamp, for use on vehicles 2032 mm or more in overall width |
| 17 | Front mounted turn signal lamps mounted less than 100 mm from the headlamp, for use on vehicles 2032 mm or more in overall width |
| J590 | Turn signal flasher |
| J945 | Hazard warning signal flasher |
| J1054 | Warning lamp alternating flasher |
| K | Front cornering lamps |
| K2 | Rear cornering lamps |
| L | License plate lamps |
| M | Motorcycle and motor-driven cycle headlamps—motorcycle type |
| N | Motorcycle and motor-driven cycle headlamps—motor driven cycle type |
| O | Spot lamps |

| | |
|-------------|-------------------------------------------------------------------------------------------------------|
| P | Parking lamps |
| P2 | Clearance, side marker, and identification lamps |
| P3 | Clearance, side marker, and identification lamps for use on vehicles 2032 mm or more in overall width |
| PC | Combination clearance and side marker lamps |
| PC2 | Combination clearance and side marker lamps for use on vehicles 2032 mm or more in overall width |
| Q | Turn signal operating units—Class A |
| QB | Turn signal operating units—Class B |
| QC | Vehicular hazard warning signal operating unit |
| R | Backup lamps |
| S | Stop lamps |
| S2 | Stop lamp for use on vehicles 2032 mm or more in overall width |
| T | Tail lamps (rear position lamps) |
| T2 | Tail lamps (rear position lamps) for use on vehicles 2032 mm or more in overall width |
| U | Supplemental high-mounted stop and turn signal lamps |
| U2 | High-mounted stop lamps for trucks 2032 mm or more in overall width |
| U3 | Center high-mounted stop lamp for passenger cars, light trucks, and MPVs |
| W | Warning lamps for emergency, maintenance, and service vehicles |
| W2 | Warning lamps for school buses |
| W3 | 360 degree emergency warning lamps |
| W4 | Emergency warning device |
| W5-1 | 360 degree gaseous discharge lamp—Class 1 |
| W5-2 | 360 degree gaseous discharge lamp—Class 2 |
| W5-3 | 360 degree gaseous discharge lamp—Class 3 |
| Y | Driving lamps |
| Y2 | Daytime running lamps |
| Z | Auxiliary low beam lamps |



LIGHTING REQUIREMENTS: TRAILERS

IMPORTANT NOTE: Every lamp, reflex reflector, and conspicuity treatment must be permanently attached in the location specified below and must comply with all applicable requirements prescribed for it by FMVSS/CMVSS 108. The face of any device on the front/rear and sides should be, respectively perpendicular and parallel to the vehicle's centerline, unless it is photometrically certified at installation angle. No part of the vehicle shall prevent any device from meeting its prescribed requirements unless an auxiliary device meeting all prescribed requirements is installed.

BASIC EQUIPMENT REQUIRED ON ALL TRAILERS

| DESCRIPTION | | MANDATORY REQUIREMENTS | | | | | |
|-------------|------------------------------|------------------------|----------------------------------------|-----------|--------------|-----------------------------------------------------------------------|-----------------------------------------------------------|
| Area | Equipment | SAE Lens Coding | Functional Purpose | Quantity | Color | Location | Height mm(in.) from the ground |
| 1 | Tail Lamps | (T) | Indicate vehicle's presence and width | Minimum 2 | Red | On the rear - symmetrical as far apart as practicable | 380-1830 (15-72) |
| | Stop Lamps | (S) | Indicate braking | Minimum 2 | Red | On the rear - symmetrical as far apart as practicable | 380-1830 (15-72) |
| | Rear Turn Signal Lamps | (I) | Indicate direction of turn | Minimum 2 | Red or Amber | On the rear - symmetrical as far apart as practicable | 380-2110 (15-83) |
| | Rear Reflex Reflectors | (A) | Indicate vehicle's presence and width | Minimum 2 | Red | On the rear - symmetrical as far apart as practicable facing rearward | 380-1530 (15-60) |
| 2 | License Plate Lamp(s) | (L) | Illuminates license plate | Minimum 1 | White | On the rear - above or at the sides of license plate | No requirement |
| 3 | Rear Side Marker Lamps | (P2, PC* or P3, PC2*) | Indicate vehicle's presence and length | Minimum 2 | Red | Each side at rear as far back as practicable | 380-1530 (15-60) no max. for veh. under 2032mm (80") wide |
| | Rear Side Reflex Reflectors | (A) | | Minimum 2 | Red | Each side at rear as far back as practicable facing sideward | 380-1530 (15-60) |
| 4 | Front Side Marker Lamps | (P2, PC* or P3, PC2*) | Indicate vehicle's presence and length | Minimum 2 | Amber | Each side at front as far forward as practicable | 380 (15) minimum |
| | Front Side Reflex Reflectors | (A) | | Minimum 2 | Amber | Each side at front as far forward as practicable facing sideward | 380-1530 (15-60) |

ADDITIONAL EQUIPMENT FOR TRAILERS EXCEEDING THE FOLLOWING PARAMETERS

Length 9.1m (30 ft.) or longer

| DESCRIPTION | | MANDATORY REQUIREMENTS | | | | | |
|-------------|-------------------------------------|------------------------|-------------------------------------|-----------|-------|---------------------------------------|--------------------------------|
| Area | Equipment | SAE Lens Coding | Functional Purpose | Quantity | Color | Location | Height mm(in.) from the ground |
| 5 | Intermediate Side Marker Lamps | (P2, P3, PC* or PC2*) | Indicate presence of a long vehicle | Minimum 2 | Amber | Each side near center facing sideward | 380 (15) minimum |
| | Intermediate Side Reflex Reflectors | (A) | Indicate presence of a long vehicle | Minimum 2 | Amber | Each side near center facing sideward | 380-1530 (15-60) |



LIGHTING REQUIREMENTS: TRAILERS

Width 2032mm (80 in.) or wider

| DESCRIPTION | | MANDATORY REQUIREMENTS | | | | | |
|-------------|---------------------------------------------------------------------------|------------------------|-------------------------------------------------------------|-----------|-------|------------------------------------------------------------------------------------------------------|---------------------------------------------------------------------|
| Area | Equipment | SAE Lens Coding | Functional Purpose | Quantity | Color | Location | Height |
| 6 | Rear Clearance Lamps *photometrically certified at installation angle | (P2, PC* or P3, PC2*) | Show vehicle's width MAY NOT be combined with tail lamps | Minimum 2 | Red | At widest point - symmetrical on the rear or near the rear facing rearward | As high as practicable may be lower only if ID lamps are at the top |
| 7 | Rear Identification (ID) Lamps | (P2 or P3) | Indicate presence of a wide vehicle | Exactly 3 | Red | On the rear - center horizontally spaced 150mm (6 in.) apart to 300mm (12 in.) apart facing rearward | At the top - may be lower if door header narrower than 25mm |
| 8 | Front Clearance Lamps *photometrically certified at installation angle | (P2, PC* or P3, PC2*) | Show vehicle's width | Minimum 2 | Amber | At widest point - symmetrical on the front or near the front facing forward | As high as practicable |

Width 2032mm (80 in.) or wider AND GVWR 4536 kg (10,000 lb.) or more

| DESCRIPTION | | MANDATORY REQUIREMENTS | | | Options | | |
|-------------|--------------------------|-------------------------------------|--------------------------------------|-------------------------|---------------------------------------------------------------------------------------------------------------------------------------------------------------------|---------------------------------------------------------------------------------------------------------|------------------------------------------------------------------------------------------------------------------------------------------|
| Area | Conspicuity Treatment | DOT Coding | Quantity | Color | Location | Height | |
| 9 | Rear Upper Body Markings | | Exactly 2 pairs of 300mm long strips | White | On the rear upper corners facing rearward | At the top | Reflex reflectors may not be required if they are replaced in their required location with conspicuity treatment. |
| 10 | Bumper Bar Marking | DOT-C DOT-C2 DOT-C3 DOT-C4 | Continuous | Red/White | On the rear bumper bar's horizontal element full width - facing rearward | No requirement | Optional in Canada: Rear lower body and side conspicuity treatment may also be solid white, solid yellow, or white and yellow. |
| 11 | Rear Lower Body Marking | | Continuous | Red/White (see options) | On the rear full width of the vehicle facing rearward | As horizontal as practicable and as close as practicable to the ground of 375 to 1525mm from the ground | |
| 12 | Side Marking | | (see location) | Red/White (see options) | Each side - facing sideward continuous, or evenly spaced over minimum of 50% of length starts and ends as close to the front and rear of the vehicle as practicable | As horizontal as practicable and as close as practicable to the range of 375 to 1525mm from the ground | |

NOTE: The edge of red conspicuity tape shall not be closer than 75 mm to the edge of any amber lamp and the edge of white conspicuity tape shall not be closer than 75 mm to the edge of any lamp



LIGHTING REQUIREMENTS: TRAILERS

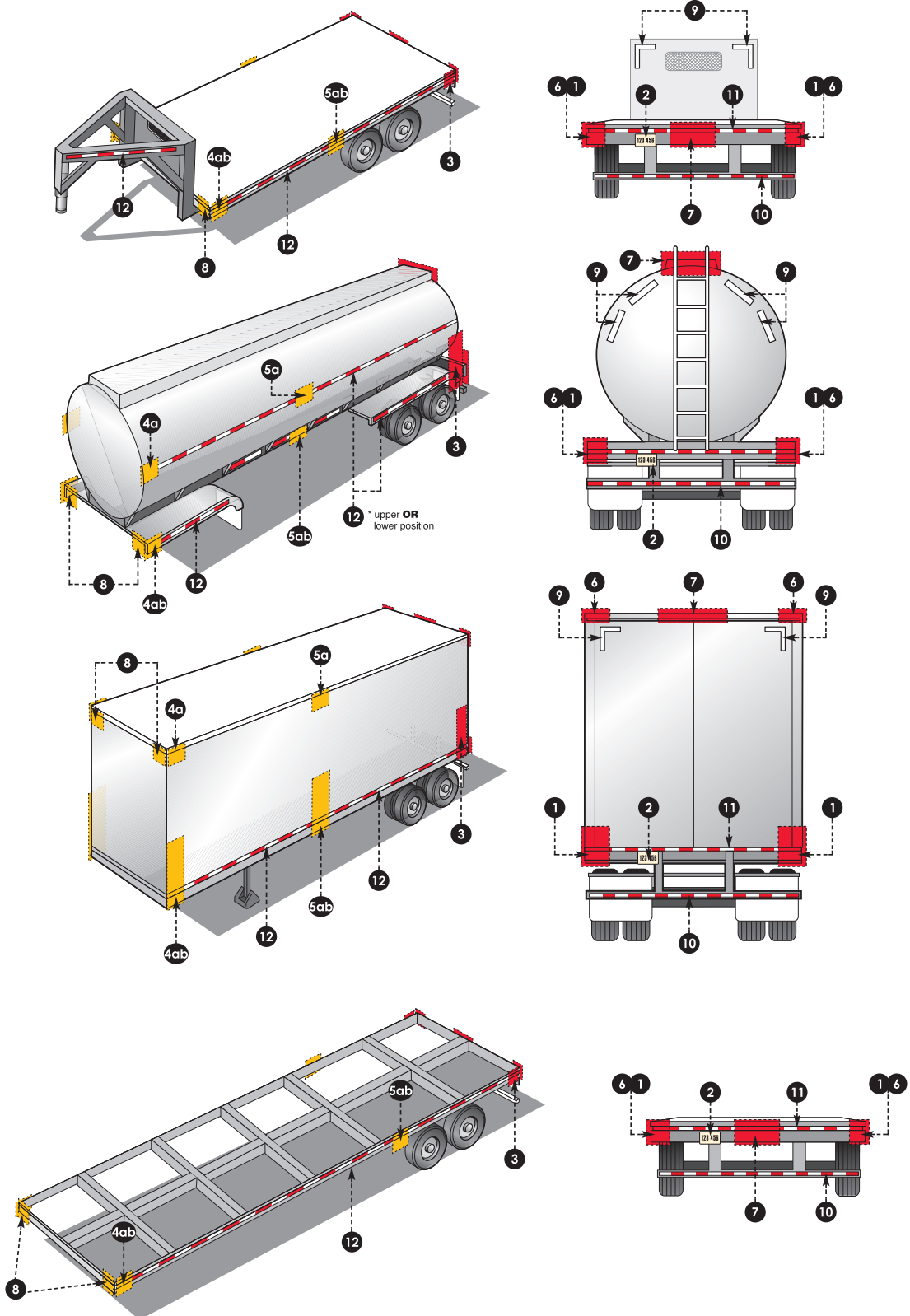



LIGHTING REQUIREMENTS: TRAILERS

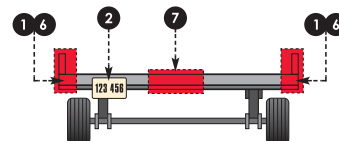
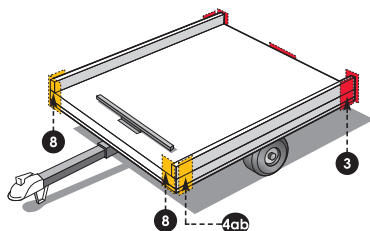
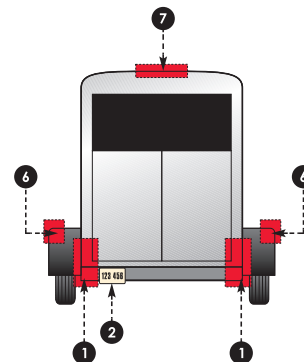
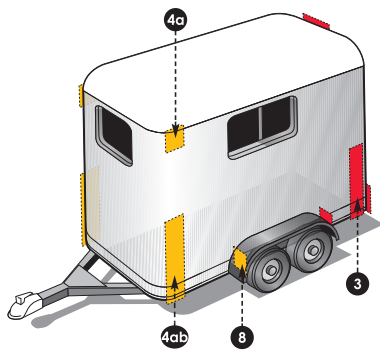
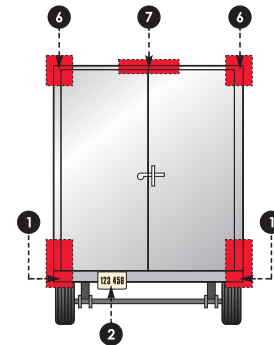
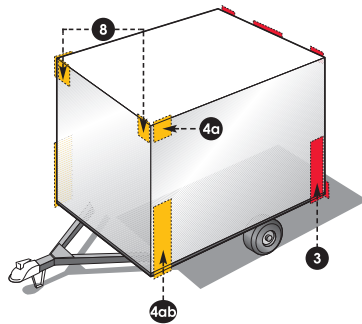
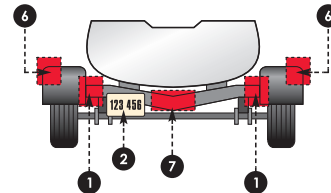
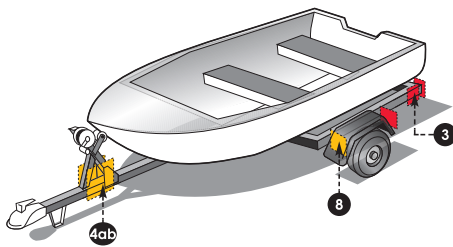
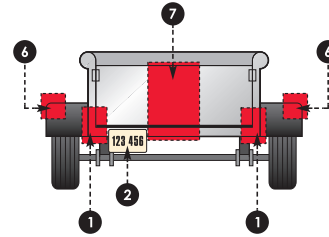
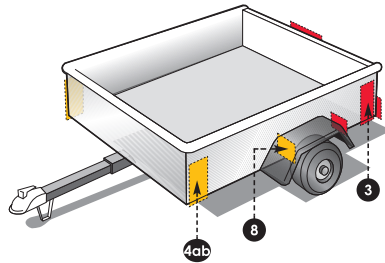



LIGHTING REQUIREMENTS: TRUCKS, BUSES, & MPVs

IMPORTANT NOTE: Every lamp, reflex reflector, and conspicuity treatment must be permanently attached in the location specified below and must comply with all applicable requirements prescribed for it by FMVSS/CMVSS 108. The face of any device on the front/rear and sides should be, respectively perpendicular and parallel to the vehicle's centerline, unless it is photometrically certified at installation angle. No part of the vehicle shall prevent any device from meeting its prescribed requirements unless an auxiliary device meeting all prescribed requirements is installed.

BASIC EQUIPMENT REQUIRED ON ALL TRUCKS, BUSES & MPVs

| DESCRIPTION | | MANDATORY REQUIREMENTS | | | | | |
|-------------|---------------------------------------------------------------------------------------------------------------------|------------------------|--------------------------------------------------------------------------------------------------|-----------|----------------|------------------------------------------------------------------------------------------------|-----------------------------------------------------------|
| Area | Equipment | SAE Lens Coding | Functional Purpose | Quantity | Color | Location | Height mm(in.) from the ground |
| 1 | Headlamps - Lower Beam | (H, HR) | Forward road illumination | Minimum 2 | White | On the front - symmetrical as far apart as practicable | 560-1370 (22-54) |
| | US requires "DOT" lettering on lens US&Canada - light source code required on lens | | | | | If 4 lamp system - outboard or above upper beams | |
| 2 | Headlamps - Upper Beam | (H, HR) | Forward road illumination | Minimum 2 | White | On the front - symmetrical as far apart as practicable | 560-1370 (22-54) |
| | US requires "DOT" lettering on lens US&Canada - light source code required on lens | | | | | If 4 lamp system - inboard or below lower beams | |
| 3 | Parking Lamps | (P) | Indicate parked vehicle | Minimum 2 | White or amber | On the front - symmetrical as far apart as practicable | 380-1830 (15-72) |
| | Vehicles less than 2032mm wide | | | | | | |
| 4 | Daytime Running Lamps (DRL) | (Y2) | Indicate in use vehicle | Minimum 2 | White or amber | On the front - symmetrical as far apart as practicable | 380 (15) min. Max. depends on type of DRL |
| | Canada - required / US - option US requires "DRL" lettering on lens if not headlamp | | | | | | |
| 5 | Front Turn Signal/Hazard Warning Lamps | (I) | Indicate direction of turn/identify disabled vehicle | Minimum 2 | Amber | On the front - symmetrical as far apart as practicable | 380-2110 (15-83) |
| | Vehicles 2032mm wide or wider *photometrically certified at installation angle | | | | | At widest point - symmetrical on the front or near the front facing forward | As high as practicable |
| 6 | Front Identification Lamps (ID) | (P2 or P3) | Indicate presence of a wide vehicle | Exactly 3 | Amber | On the front - center horizontally spaced 150 mm (6 in.) to 300 mm (12 in.) apart | As high as practicable or on top of the cab |
| | Vehicles 2032mm wide or wider | | | | | | |
| 7 | Front Side Marker Lamps | (P2, PC* or P3, PC2*) | Show vehicle's width | Minimum 2 | Amber | Each side at front as far forward as practicable | 380 (15) minimum |
| | Vehicles 2032mm wide or wider | | | | | | |
| 8 | Front Side Reflex Reflectors | (A) | Front and rear side marker lamps / side reflex reflectors indicate vehicle's presence and length | Minimum 2 | Amber | Each side at front as far forward as practicable facing sideward | 380-1530 (15-60) |
| | Vehicles 2032mm wide or wider | | | | | | |
| 9 | Rear Side Marker Lamps ** | (P2, PC* or P3, PC2*) | Show vehicle's width MAY NOT be combined with tail lamps | Minimum 2 | Red | Each side at rear as far back as practicable | 380 (15) minimum |
| | Vehicles 2032mm wide or wider Not required on Truck Tractors *photometrically certified at installation angle | | | | | | |
| 10 | Rear Side Reflex Reflectors ** | (A) | Indicate presence of a wide vehicle | Minimum 2 | Red | Each side at rear as far back as practicable facing sideward | 380-1530 (15-60) |
| | Vehicles 2032mm wide or wider Not required on Truck Tractors *photometrically certified at installation angle | | | | | | |
| 11 | Rear Identification (ID) Lamps | (P2 or P3) | Indicate presence of a wide vehicle | Exactly 3 | Red | On the rear - center horizontally spaced 150mm (6 in.) to 300mm (12 in.) apart facing rearward | At the top may be lower if door header narrower than 25mm |
| | Vehicles 2032mm wide or wider Not required on Truck Tractors | | | | | | |



LIGHTING REQUIREMENTS: TRUCKS, BUSES, & MPVs

| | | | | | | | |
|-----------|-------------------------------------------------------------------------------------------------|--------------------------|------------------------------------------------------------------------------------------------------------------------------------------------------------|--------------------------------------------------------------|-----------------------------------|----------------------------------------------------------------------------------------------------------------------------------------------------------------------------------------------------------------------------------|------------------------------------------------------------------------------|
| 8 | Tail Lamps Stop Lamps Rear Turn Signal/ Hazard Warning Lamps Rear Reflex Reflectors | (T) (S) (I) (A) | Indicate vehicle's presence and width Indicate braking Indicate direction of turn/ identify disabled vehicle Show vehicle's presence and width | Minimum 2 Minimum 2 Minimum 2 Minimum 2 | Red Red Red or amber Red | On the rear - symmetrical as far apart as practicable On the rear - symmetrical as far apart as practicable On the rear - symmetrical as far apart as practicable On the rear - symmetrical as far apart as practicable | 380-1830 (15-72) 380-1830 (15-72) 380-2110 (15-83) 380-1530 (15-60) |
| 9 | Backup Lamp | (R) | Illuminates ground behind the vehicle and alert road users | Minimum 1 | White | Rear | No requirement |
| 10 | License Plate Lamp(s) | (L) | Illuminates license plate | Minimum 1 | White | On the rear - above or at the sides of license plate | No requirement |
| 11 | Center High Mounted Stop Lamp <small>Vehicles less than 2032mm wide and 4536kg</small> | (U3) | Indicates braking | 1 | Red | On the rear - centerline of the vehicle | 860 (34) minimum |

ADDITIONAL EQUIPMENT FOR SPECIFIC VEHICLES VEHICLES 9.1m (30 ft.) LONG OR LONGER

| DESCRIPTION | | MANDATORY REQUIREMENTS | |
|-------------|-----------------------------------------------------------------------|------------------------|----------------------------------------------------------------------------|
| Area | Equipment | SAE Lens Coding | Functional Purpose |
| 12 | Intermediate Side Marker Lamps Intermediate Side Reflex Reflectors | (P2 or P3) (A) | Indicate presence of a long vehicle Indicate presence of a long vehicle |
| | | Quantity | Color |
| | | Minimum 2 | Amber |
| | | Minimum 2 | Amber |
| | | | Location |
| | | | Each side near center |
| | | | Each side near center facing sideward |
| | | | Height mm(in.) from the ground |
| | | | 380 (15) minimum |
| | | | 380-1530 (15-60) |

Truck Tractors

| DESCRIPTION | | MANDATORY REQUIREMENTS | |
|-------------|--------------------------|--------------------------------------|-------------------------------------------------------------------------------------------------------|
| Area | Conspicuity Treatment | DOT Coding | Quantity |
| 13 | Rear Upper Body Markings | White | Exactly 2 pairs of 300mm long strips |
| 14 | Rear Marking | Red/ White | Exactly 2 sections of min. 600mm each |
| | | Color | Location |
| | | White | Rear upper corners of cab facing rearward |
| | | Red/ White | Rear - facing rearward - on fenders, on mud flap brackets, or within 300mm below the top of mud flaps |
| | | Quantity | Height |
| | | Exactly 2 pairs of 300mm long strips | As high as practicable excluding fairings |
| | | DOT-C DOT-C2 DOT-C3 DOT-C4 | As horizontal as practicable and not higher than 1525mm from the ground |
| | | | Options |
| | | | If mud flaps not used - on the cab or frame mounted brackets |

NOTE: The edge of red conspicuity tape shall not be closer than 75 mm to the edge of any amber lamp and the edge of white conspicuity tape shall not be closer than 75 mm to the edge of any lamp



LIGHTING REQUIREMENTS: TRUCKS, BUSES, & MPVS

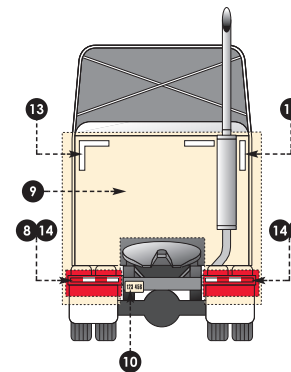
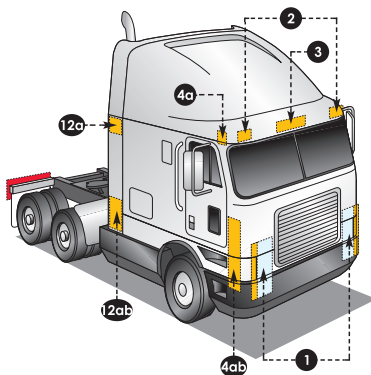
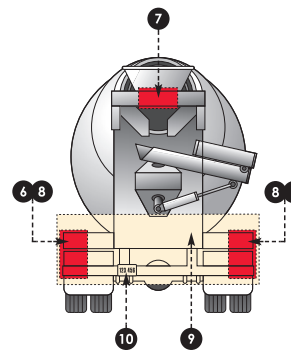
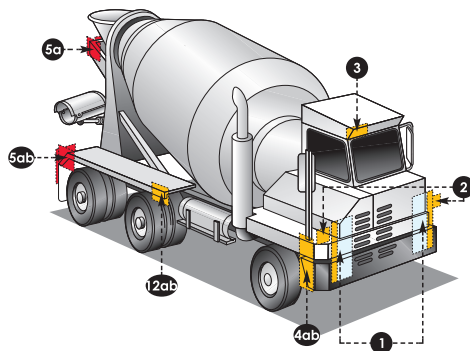
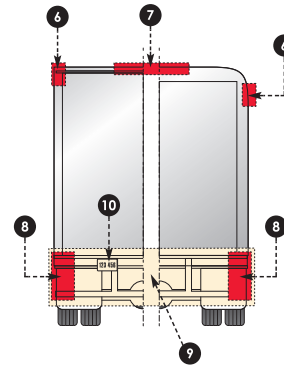
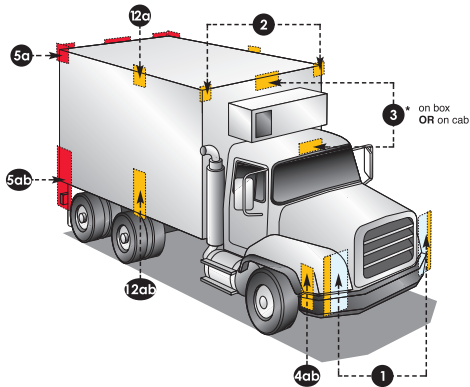
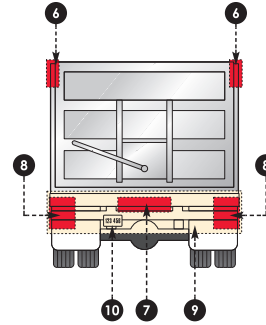
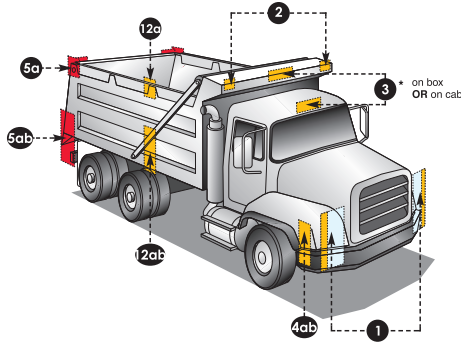



LIGHTING REQUIREMENTS: TRUCKS, BUSES, & MPVS

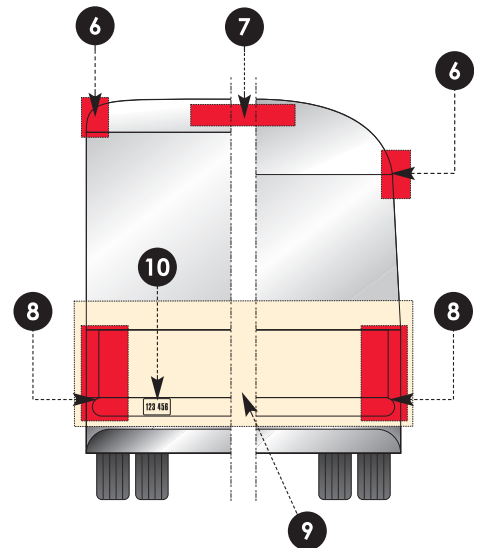
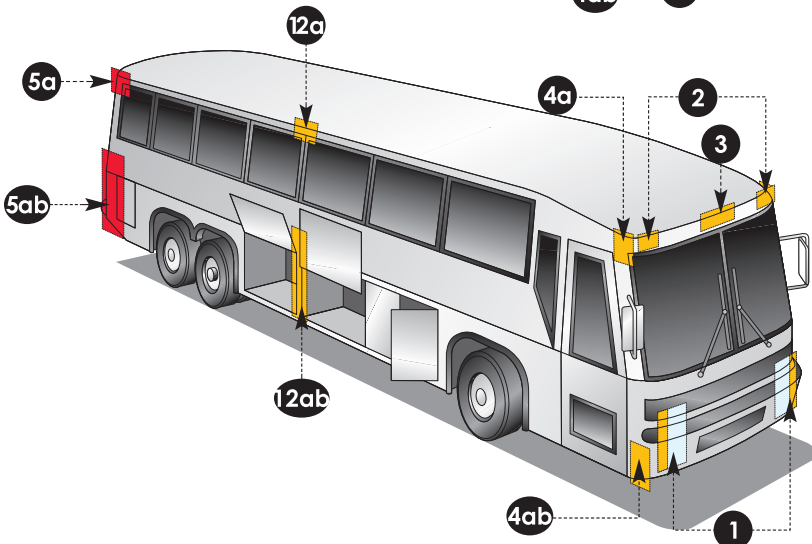
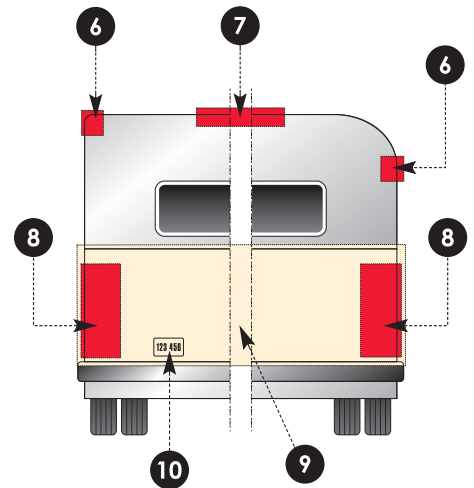
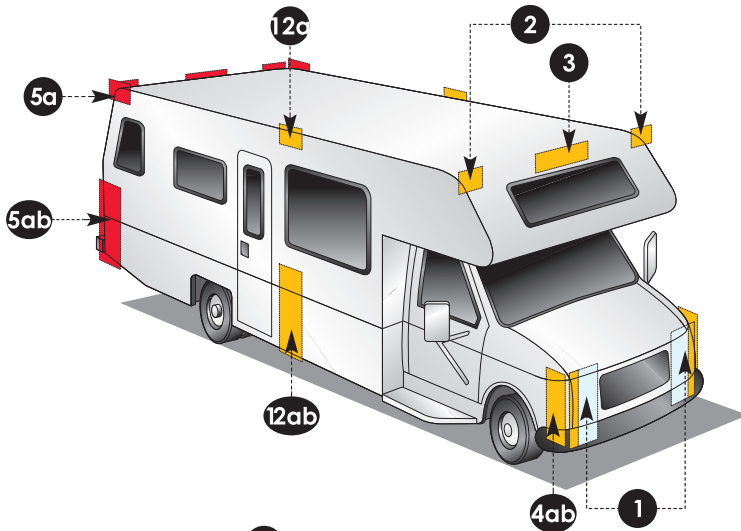
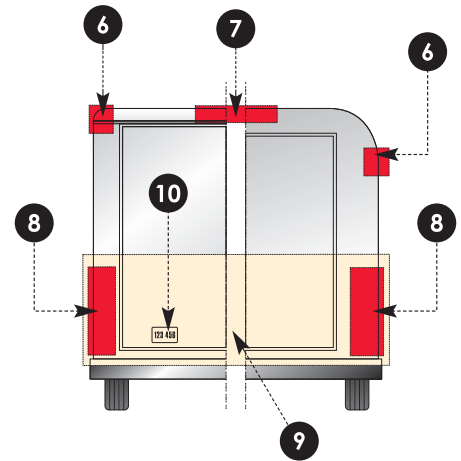
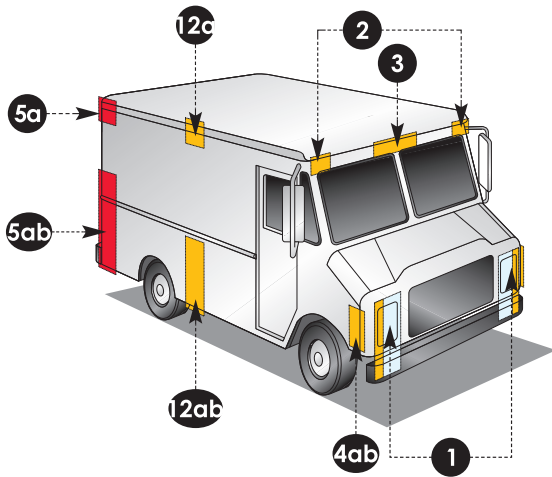





Warranty Information

UBLights Lighting and Safety Products (UBL) extends a Limited Warranty to the original purchaser that the warranted products are free from defects in workmanship and/or materials only, whereby UBL will replace any warranted product to the original consumer/purchaser if the product fails because of defect due to workmanship and/or materials within the limited warranty period from the date imprinted on the product. Each Limited Warranty as applicable is not transferable and applies to the original installation of the UBL product. To be eligible for Limited Warranty protection the UBL products must remain intact, free from physical abuse, and not subject to improper installation. This offer does not constitute in any way a product guarantee and UBL does not hereby assume any obligation of any kind whatsoever beyond sending a free replacement product. Unless expressly agreed to in writing by UBL, UBL does not warrant its products as to their fitness for any special use or function. UBL believes our products should provide good service under proper operating conditions.

In order to return merchandise for warranty replacement, you must have a Return Merchandise Authorization (RMA) number. Once an RMA is provided, the product must be shipped back to UBL warehouse for inspection. UBLights Lighting & Safety Products 17311 Martec Int'l Blvd, Country Club Hills, IL 60478. We will only accept once RMA is released. Please include a copy of your original invoice (proof of purchase). Please be sure that your RMA number is clearly marked on your documentation as well as on the outside of the packaging used for shipping. Shipping cost to return merchandise back to UBL is the responsibility of the customer. Items received will not be returned.

By completing the steps above, this will ensure faster processing of your claim so that UBL can get your product back to you as quickly as possible. UBLights Lighting and Safety is not liable for any charges incurred by the Customer relating to installation, repair or removal of product. UBLights Lighting and Safety warrants that this product will be free from defects in material and workmanship. If you believe your UBL product is defective, it must be returned to us for inspection by our warranty claims department. After inspection, UBL will verify that the defect was not caused by negligence, abuse, unauthorized repair or disassembly. UBLights Lighting and Safety will determine whether the product will be repaired or replaced in accordance with Limited Warranty. If UBL, in its sole discretion, finds that your product is defective in material or workmanship, UBL will honor your warranty claim. In some cases, the product will be replaced depending on the specific time-frame of the purchase. If the product is repaired, all parts, labor, and return shipping may be covered by UBL.

All warranties are non-transferable. Warranty terms and policies are subject to change without notice.

- DOT LED Lighting has a limited lifetime warranty against defects in workmanship.
- LED Strobe & Work Lights have a 5 year warranty
- All Incandescent lighting has a 1 year warranty





Alphabetical Index

| | | | | | |
|-------------------|----|-----------------------|----|-------------------------|----|
| MTAG4040..... | 55 | MTKTL2000-4R..... | 26 | MTLED2238-7R..... | 3 |
| MTAG4045..... | 55 | MTKTL2000-10A..... | 26 | MTLED2238-10A..... | 1 |
| MTAX4411..... | 55 | MTKTL2000-10R..... | 26 | MTLED2238-10A-AMP..... | 1 |
| MTAXB4411..... | 55 | MTKTL2001-9A..... | 27 | MTLED2238-10C..... | 1 |
| MTBD2000..... | 57 | MTKTL2001-9R..... | 27 | MTLED2238-10R..... | 1 |
| MTBM102ORB..... | 57 | MTKTL2238-10A..... | 27 | MTLED2238-10R-AMP..... | 1 |
| MTBM1040B..... | 57 | MTKTL2238-10R..... | 27 | MTLED2238-13R..... | 1 |
| MTBM1040BB..... | 57 | MTKTL2238-24C..... | 27 | MTLED2238-24A..... | 2 |
| MTBM1040BC..... | 57 | MTKTL2238C-10R..... | 27 | MTLED2238-24C..... | 2 |
| MTBM2500G..... | 57 | MTKTL4000-10A..... | 28 | MTLED2238-24R..... | 2 |
| MTCX500SS..... | 69 | MTKTL4000-10R..... | 28 | MTLED2238C-10R..... | 3 |
| MTCX600SS..... | 69 | MTKTL4000-12R..... | 28 | MTLED2238C-24A..... | 3 |
| MTCX750SS..... | 69 | MTKTL4000-12R..... | 28 | MTLED2238CB-12R16C..... | 3 |
| MTCX755SS..... | 69 | MTKTLEDW2238-24A..... | 21 | MTLED2500-2A-ABS..... | 12 |
| MTCX850SS..... | 69 | MTKTLEDW2238-24R..... | 21 | MTLED2500-4A..... | 12 |
| MTCX855SS..... | 69 | MTLB2000R..... | 43 | MTLED2500-4R..... | 12 |
| MTFL2001..... | 58 | MTLB2500R..... | 43 | MTLED2500-12A..... | 11 |
| MTFL2002..... | 58 | MTLBL2000R..... | 38 | MTLED2500-12R..... | 12 |
| MTFL2005..... | 58 | MTLBL2500R..... | 38 | MTLED2500-13A..... | 12 |
| MTFL2238-1..... | 58 | MTLDL3060-12C..... | 20 | MTLED2500-13R..... | 12 |
| MTFL2238-2..... | 58 | MTLDL60180-48..... | 20 | MTLED2500C-13A..... | 13 |
| MTFL2238SS..... | 59 | MTLED0700A..... | 7 | MTLED2500C-13R..... | 13 |
| MTFL2502..... | 59 | MTLED0700A-BLT..... | 8 | MTLED4000-1C..... | 17 |
| MTFL2505..... | 59 | MTLED0700ADF-BLT..... | 8 | MTLED4000-6A..... | 18 |
| MTFL4000SS..... | 59 | MTLED0700C..... | 8 | MTLED4000-7C..... | 18 |
| MTFL4002..... | 59 | MTLED0700CA..... | 8 | MTLED4000-7R..... | 19 |
| MTFL4005..... | 59 | MTLED0700CA-BLT..... | 8 | MTLED4000-10A..... | 16 |
| MTFL4060SS..... | 60 | MTLED0700CB..... | 9 | MTLED4000-10C..... | 16 |
| MTFM4102R..... | 39 | MTLED0700C-BLT..... | 8 | MTLED4000-10R..... | 17 |
| MTFM4202RA..... | 39 | MTLED0700CR..... | 9 | MTLED4000-10R-1..... | 17 |
| MTFM4302AA..... | 39 | MTLED0700CR-BLT..... | 9 | MTLED4000-12A..... | 17 |
| MTFM5403RA..... | 39 | MTLED0700R..... | 9 | MTLED4000-12R..... | 17 |
| MTFMR4102A..... | 39 | MTLED0700R-BLT..... | 9 | MTLED4000-24A..... | 17 |
| MTGR2000..... | 60 | MTLED0700RDF-BLT..... | 9 | MTLED4000-24C..... | 18 |
| MTGR2001..... | 60 | MTLED0750-6A..... | 4 | MTLED4000-24R..... | 18 |
| MTGR2238..... | 60 | MTLED0750-6R..... | 4 | MTLED4000-40A..... | 18 |
| MTGR2239..... | 60 | MTLED0750A..... | 5 | MTLED4000-40R-1..... | 18 |
| MTGR2500..... | 60 | MTLED0750R..... | 5 | MTLED4000C-24R..... | 19 |
| MTGR2501..... | 61 | MTLED1040-6A..... | 5 | MTLED4000CB-12R16C..... | 19 |
| MTGR2502..... | 61 | MTLED1040-6R..... | 5 | MTLED4060-24A..... | 7 |
| MTGR4000..... | 61 | MTLED1225-1C..... | 5 | MTLED4060-24R..... | 7 |
| MTGR4060..... | 61 | MTLED1225-3A..... | 5 | MTLED7000-17A..... | 19 |
| MTHW1001..... | 70 | MTLED1225-3R..... | 6 | MTLED7200R..... | 26 |
| MTHW1002..... | 70 | MTLED2000-1A..... | 10 | MTLEDAX4411-6C..... | 34 |
| MTJB0700..... | 58 | MTLED2000-1A-ABS..... | 10 | MTLEDAX4411-19C..... | 34 |
| MTKT2140R..... | 39 | MTLED2000-1R..... | 10 | MTLEDAX4411-19C..... | 34 |
| MTKT3200A..... | 40 | MTLED2000-4A..... | 10 | MTLED2000-1A-ABS..... | 13 |
| MTKT3200R..... | 40 | MTLED2000-4R..... | 11 | MTLED2000-1R..... | 10 |
| MTKT3205A..... | 40 | MTLED2000-9A..... | 11 | MTLED2000-4A..... | 10 |
| MTKT3205R..... | 40 | MTLED2000-9R..... | 11 | MTLED2000-4R..... | 11 |
| MTKT3255A..... | 40 | MTLED2000-10A..... | 10 | MTLED2000-9A..... | 11 |
| MTKT3255R..... | 40 | MTLED2000-10R..... | 10 | MTLED2000-9R..... | 11 |
| MTKT3260A..... | 41 | MTLED2000C-10A..... | 11 | MTLED2000-10A..... | 10 |
| MTKT3260C..... | 41 | MTLED2000C-10R..... | 11 | MTLED2000-10R..... | 10 |
| MTKT3260R..... | 41 | MTLED2040A..... | 6 | MTLED2000C-10A..... | 11 |
| MTKT3260W..... | 41 | MTLED2040R..... | 6 | MTLED2000C-10R..... | 11 |
| MTKT3405A..... | 41 | MTLED2238-1C..... | 2 | MTLED2040A..... | 6 |
| MTKT3405C..... | 41 | MTLED2238-1R..... | 2 | MTLED2040R..... | 6 |
| MTKT3405R..... | 42 | MTLED2238-6A..... | 2 | MTLED2238-1C..... | 2 |
| MTKT3405W..... | 42 | MTLED2238-6C..... | 3 | MTLED2238-1R..... | 2 |
| MTKTL2000-4A..... | 26 | MTLED2238-6R..... | 3 | MTLED2238-6A..... | 2 |
| | | | | MTLED2238-6C..... | 3 |
| | | | | MTLED2238-6R..... | 3 |



Alphabetical Index

| | | | | | |
|-------------------------|----|------------------------|----|--------------------|----|
| MTLEDRF2000-1RH..... | 15 | MTLW0303-4S..... | 31 | MTPT6800-DT1..... | 67 |
| MTLEDRF2500-1A-AMP..... | 15 | MTLW0303-6F..... | 31 | MTPT6800-DT2..... | 67 |
| MTLEDRF2500-1AC..... | 15 | MTLW0303-6S..... | 31 | MTPT9120..... | 63 |
| MTLEDRF2500-1AH..... | 15 | MTLW2040-2B..... | 35 | MTPT9180..... | 64 |
| MTLEDRF2500-1R-AMP..... | 15 | MTLW2040-2R..... | 35 | MTPT9181..... | 64 |
| MTLEDRF2500-1RC..... | 16 | MTLW3030-MRS-5..... | 31 | MTPT9182..... | 64 |
| MTLEDRF2500-1RH..... | 16 | MTLW4030-6..... | 32 | MTPT9183..... | 64 |
| MTLEDS2000-1A-ABS..... | 13 | MTLW5040..... | 32 | MTPT9183-BLT..... | 64 |
| MTLEDS2500-2A-ABS..... | 13 | MTLW6007..... | 35 | MTPT9520..... | 64 |
| MTLEDSF2238-10A..... | 4 | MTLW6008..... | 33 | MTPT9530..... | 65 |
| MTLEDSF2238-10R..... | 4 | MTLW6008-5..... | 33 | MTPT9532..... | 65 |
| MTLEDW1030-3CA..... | 21 | MTLW6008-18..... | 33 | MTPTOE002..... | 67 |
| MTLEDW1030-3CB..... | 21 | MTLW6008F..... | 33 | MTRF1421A..... | 65 |
| MTLEDW1030-3CR..... | 22 | MTLW6020..... | 33 | MTRF2001A..... | 65 |
| MTLEDW1030-3CW..... | 22 | MTLW7050F-MRS-COB..... | 32 | MTRF2001R..... | 65 |
| MTLEDW1035-4CA..... | 22 | MTLW50020-1..... | 34 | MTRF2012A..... | 65 |
| MTLEDW1035-4CR..... | 22 | MTLW50040-9..... | 34 | MTRF2012R..... | 66 |
| MTLEDW1035-4CW..... | 22 | MTLW50050-6..... | 34 | MTRF3001A..... | 66 |
| MTLEDW1040-4CA..... | 22 | MTLW52040-6..... | 32 | MTRF3001R..... | 66 |
| MTLEDW1040-4CAW..... | 23 | MTLW53030-5..... | 35 | MTRF3012A..... | 66 |
| MTLEDW1040-4CB..... | 23 | MTLW53500-6..... | 35 | MTRF3012R..... | 66 |
| MTLEDW1040-4CR..... | 23 | MTLW54020-33..... | 32 | MTRF3023A..... | 66 |
| MTLEDW1040-4CWW..... | 23 | MTLW54040-6..... | 35 | MTRF3023R..... | 67 |
| MTLEDW1045-6CA..... | 23 | MTLW54040-9..... | 36 | MTSB4411..... | 55 |
| MTLEDW1045-6CR..... | 24 | MTLW55050-9..... | 36 | MTSB4419..... | 55 |
| MTLEDW1045-6CW..... | 24 | MTLW56040-13..... | 32 | MTSE1040A..... | 46 |
| MTLEDW1045-6CWA..... | 23 | MTLW90803..... | 37 | MTSE1040ABS..... | 46 |
| MTLEDW2238-24A..... | 24 | MTLW91053..... | 37 | MTSE1040C..... | 46 |
| MTLEDW2238-24R..... | 24 | MTLW92003..... | 37 | MTSE1040R..... | 46 |
| MTLEDW2525-4A-6AW..... | 24 | MTLW92303..... | 37 | MTSE1225A..... | 47 |
| MTLEDW4000-24A..... | 24 | MTLW93203..... | 37 | MTSE1225C..... | 47 |
| MTLFM4102-21RA..... | 26 | MTLW94203..... | 37 | MTSE1225L..... | 47 |
| MTLH2000P..... | 61 | MTLW95003..... | 38 | MTSE1225R..... | 47 |
| MTLLB1017STT-13R..... | 38 | MTLWRL-4RGB..... | 33 | MTSE2000A..... | 48 |
| MTLLP1225-2C..... | 28 | MTLWRL-8RGB..... | 34 | MTSE2000ABS..... | 48 |
| MTLLP1225C-2..... | 28 | MTMB2238..... | 61 | MTSE2000R..... | 48 |
| MTLLP1225C-2-BLT..... | 29 | MTMB4000..... | 62 | MTSE2238A..... | 43 |
| MTLLP3000-2C..... | 29 | MTML1020R..... | 44 | MTSE2238C..... | 54 |
| MTLP1002..... | 42 | MTML2040A..... | 44 | MTSE2238R..... | 44 |
| MTLP1003..... | 42 | MTML2040R..... | 44 | MTSE2238W..... | 44 |
| MTLP2000..... | 42 | MTML2042A..... | 45 | MTSE2500A..... | 48 |
| MTLP2001..... | 43 | MTML2042R..... | 45 | MTSE2500ABS..... | 49 |
| MTLP2002..... | 43 | MTML2043A..... | 45 | MTSE2500R..... | 49 |
| MTLP3000..... | 43 | MTML2043R..... | 45 | MTSE4000A..... | 50 |
| MTLR2030-1A..... | 6 | MTML2045A..... | 45 | MTSE4000C..... | 54 |
| MTLR2030-1R..... | 6 | MTML2045R..... | 45 | MTSE4000R..... | 50 |
| MTLR2060-8A..... | 6 | MTML2540R..... | 46 | MTSE4000W..... | 51 |
| MTLR2060-8R..... | 7 | MTMLR2043R..... | 46 | MTSE4060RW..... | 48 |
| MTLR2238-9A..... | 7 | MTMR2241A..... | 47 | MTSEF2500R-2..... | 49 |
| MTLR2238-28A..... | 7 | MTMRR2041A..... | 47 | MTSEF4000R-2B..... | 51 |
| MTLR2500-4A..... | 16 | MTPT1002..... | 62 | MTSEF4000R-2S..... | 51 |
| MTLR2500-4R..... | 16 | MTPT2504..... | 67 | MTSEF4000W-2..... | 50 |
| MTLSL3050-3A..... | 25 | MTPT6020..... | 62 | MTSR2238A..... | 44 |
| MTLSL3755-6A..... | 25 | MTPT6020-3..... | 62 | MTSR2238R..... | 48 |
| MTLSL4012-3-AF..... | 25 | MTPT6020-100..... | 62 | MTSR2500A..... | 49 |
| MTLSL5030-3A..... | 25 | MTPT6020C..... | 62 | MTSR2500R..... | 49 |
| MTLSL5050-8A..... | 25 | MTPT6022..... | 63 | MTSR4000R..... | 51 |
| MTLSLM3050-3A..... | 25 | MTPT6023..... | 63 | MTSRF2000A..... | 49 |
| MTLTL6400..... | 20 | MTPT6182..... | 63 | MTSRF2000R..... | 50 |
| MTLW0302-2K..... | 31 | MTPT6183..... | 63 | MTSRF2500A-2..... | 50 |
| MTLW0303-2K..... | 31 | MTPT6800-5..... | 63 | MTSRF2500R-2..... | 50 |



Alphabetical Index

MTTL4300R 52
MTTL4305R 52
MTTL4400 52
MTTL4400K-1 42
MTTL4400L 52
MTTL4402 53
MTTL4402L 53
MTTL5441 53
MTTL5441L 53
MTTL6400 53
MTTLR6400R 53
MTTM8000U 51
MTTM8050L 51
MTTM8050R 52
MTTM8050U 52
MTTM9012L 20
MTTM9012R 20
MTW717000-1 67
MTWC3650 70
MTWC6160AL 70
MTWC6165SS 70
MTWC7160SS 70
MTWC7165SS 71





Disclaimer

The information contained in this catalog, to the best of our knowledge, is correct. Great pains have been taken in proofing this information. However, UBLights does not guarantee the enclosed data.

Illustrations and similar data in this catalog are intended only as an aid in identifying general configurations and have been obtained and developed from supplier data.

Although UBLights believes that such illustrations are accurate, and data correct, errors may exist and further verification of the part may be necessary.

UBLights

Lighting & Safety Products



17311 Martec Int'l Blvd • Country Club Hills, IL 60478

708.365.8647

ublights.com